

# Julian Assange

FROM  
HACKER  
ETHIC TO  
WIKILEAKS

DARIO MORGANTE  
GIANLUCA COSTANTINI

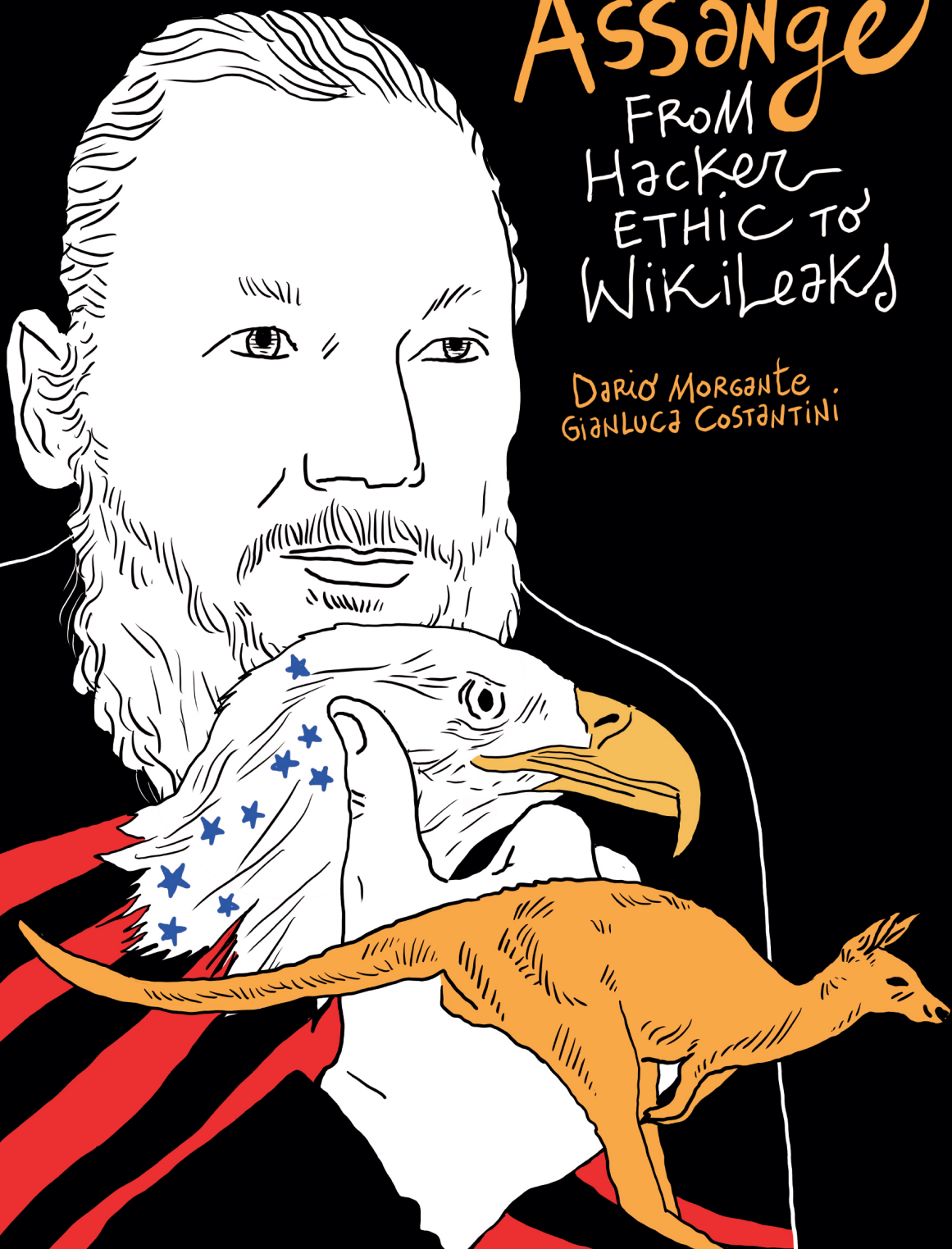



Julian  
Assange

from hacker  
ethic to  
WIKILEAKS

Dario  
Morgante  
Giulca  
CONTANTINI

Free Julian Assange



Jail The WAR  
CRIMINALS!

Published in the Italy by BeccoGiallo, Padua, 2011

Published in the Spain by Luces De Gálipo, Barcelona / Malaga, 2013

Published in the Australia by Countershock Press Publishing, Frankston, 2021

Contact:

*Gianluca Costantini* - [gianlucacostantini@protonmail.com](mailto:gianlucacostantini@protonmail.com)

[www.channeldraw.org](http://www.channeldraw.org)

## FOREWORD

---

Countershock Press Publishing welcomes this English edition of the graphic novel, *Julian Assange: From Hacker Ethic to WikiLeaks*, in the fine tradition of Italian political novels. Previously only published in Italian and Spanish, we hope it will fill in a gap in the format of material currently available in English on Julian Assange.

Notice to the Reader: The reader is asked to bear in mind that episodes in this novel, where Julian Assange is depicted fainting, or hearing voices, are only literary devices to platform internal dialogues. These were built on the little knowledge and rumour available about Assange up to 2011, which the writers dramatised in the Italian edition of this book, which came out in that year. This new version of the novel has been updated with a final chapter that takes us to 2021.

«If a rifle appears  
in the first scenes of a movie,  
be sure that sooner  
or later it will shoot.».

**John Ford**

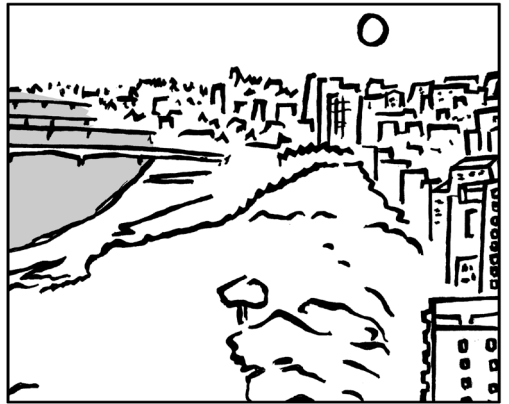

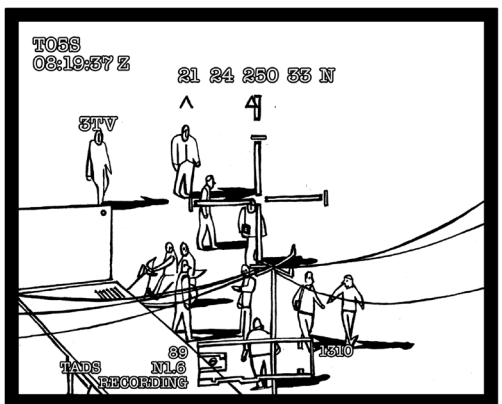
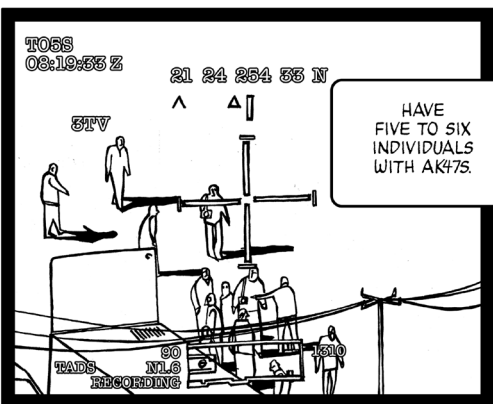
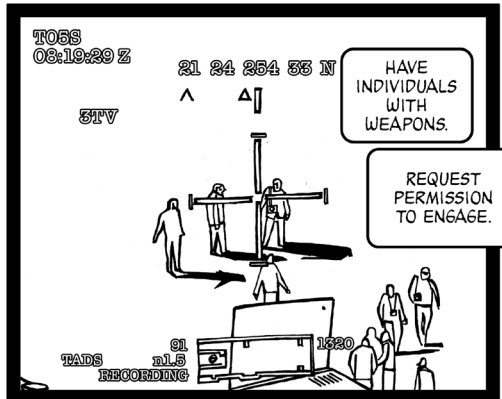
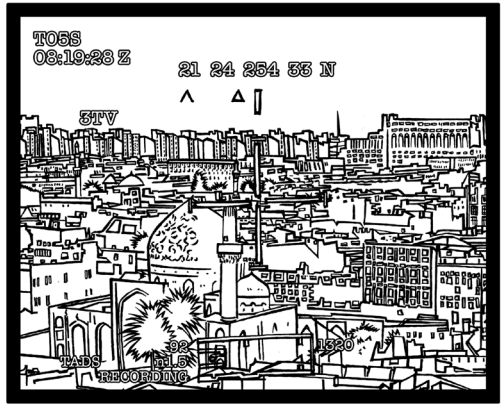

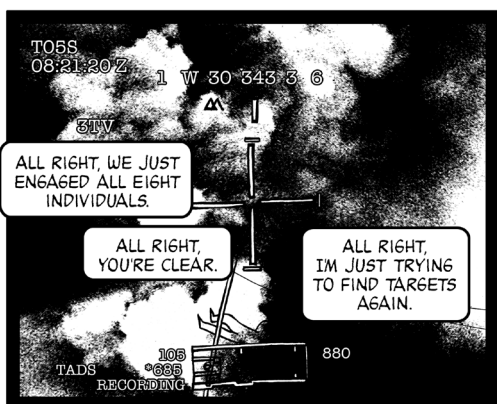
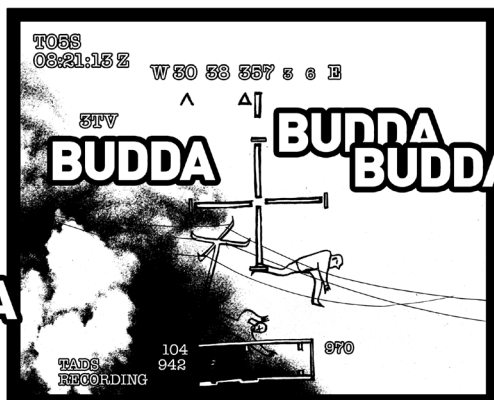
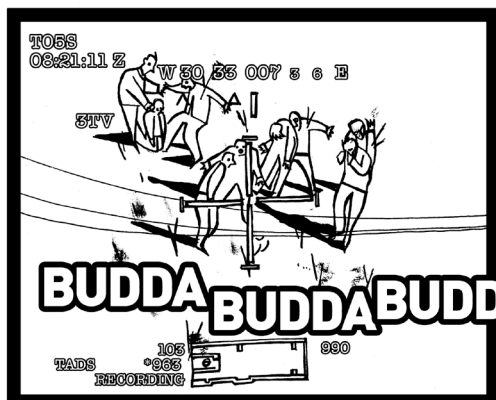
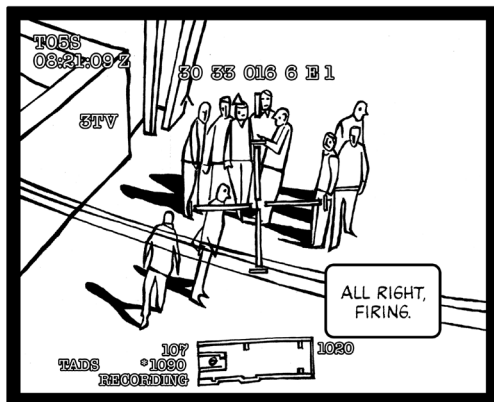
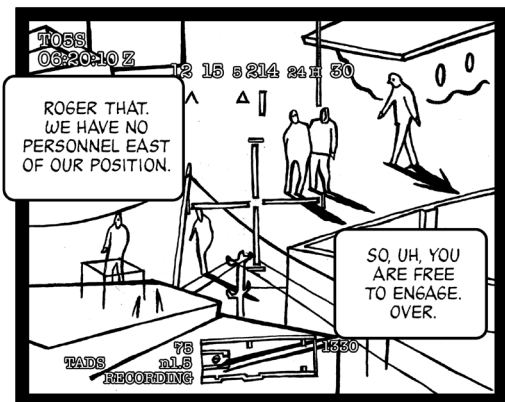

# BUDDA BUDDA BUDDA

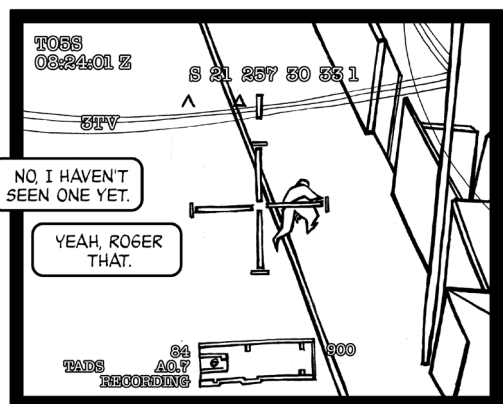
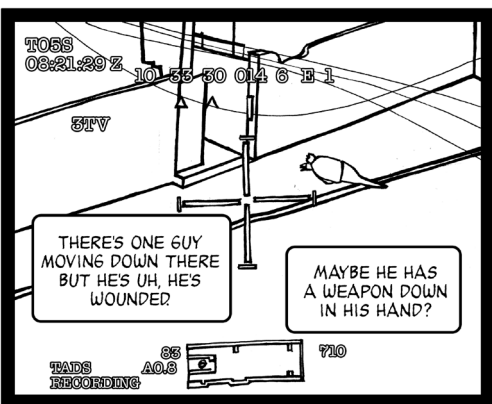
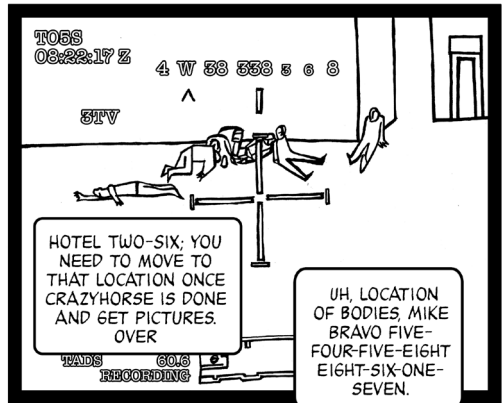
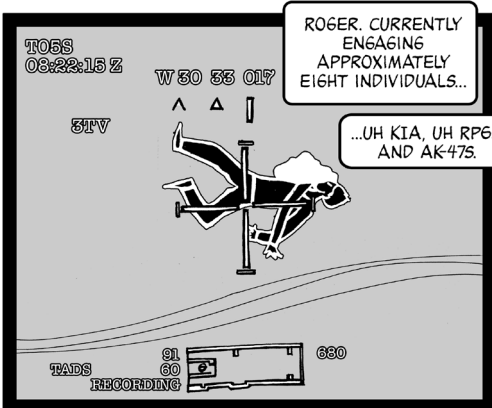
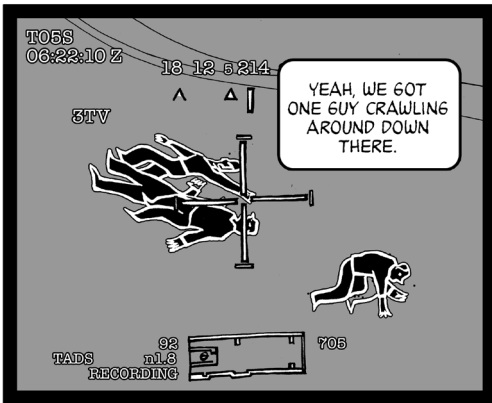

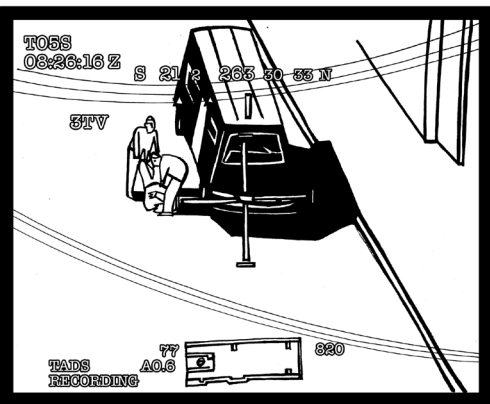
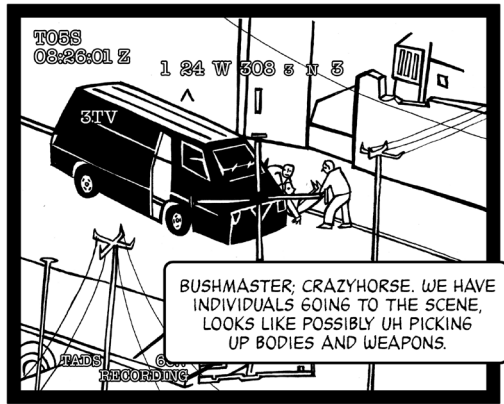
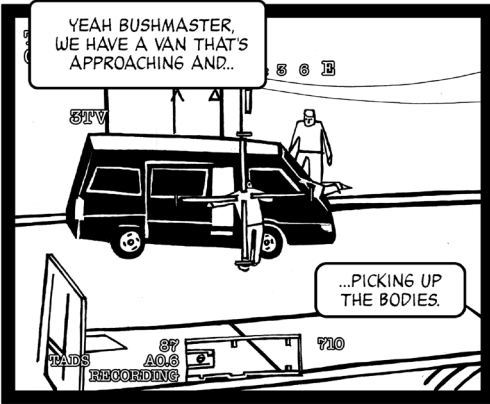
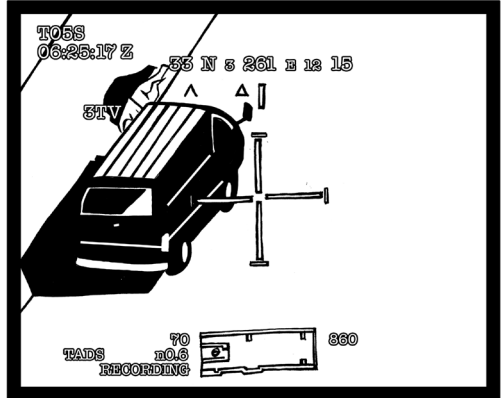
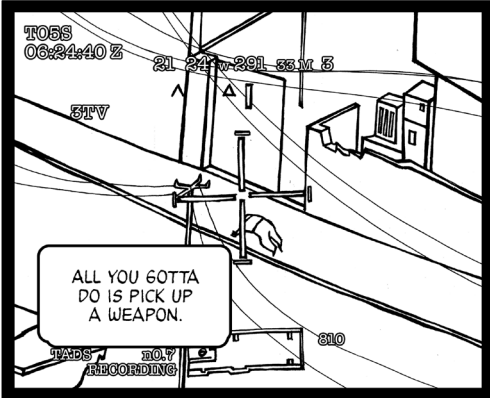

UH CRAZYHORSE ONE-EIGHT REQUEST PERMISSION TO UH ENGAGE.

THIS IS BUSHMASTER SEVEN, ROGER. EN6AGE.

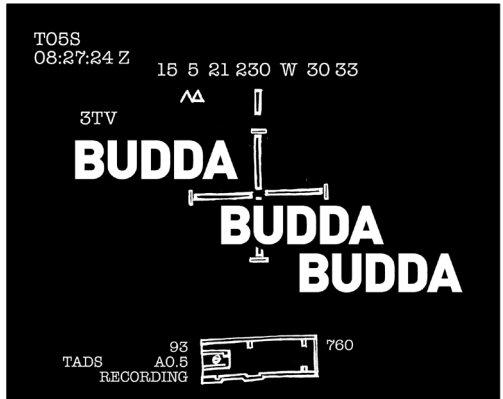
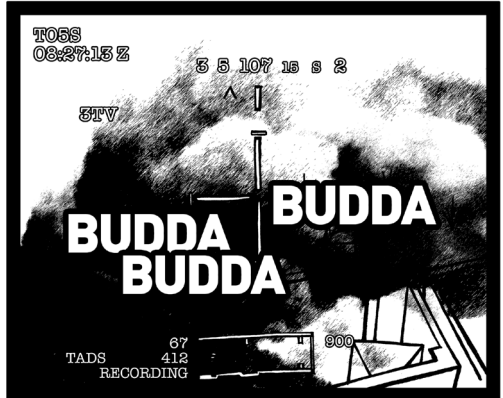
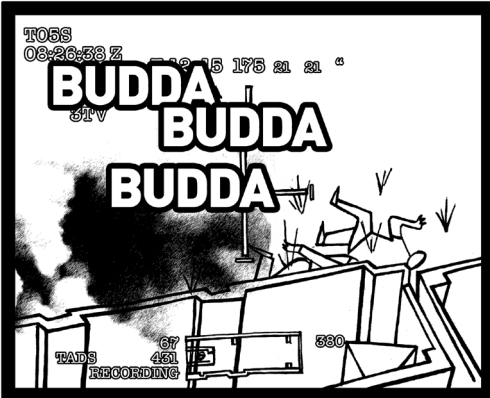
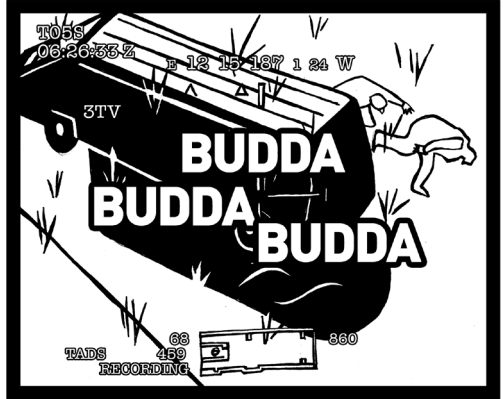
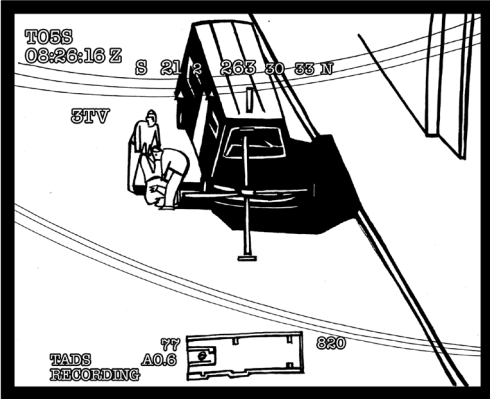

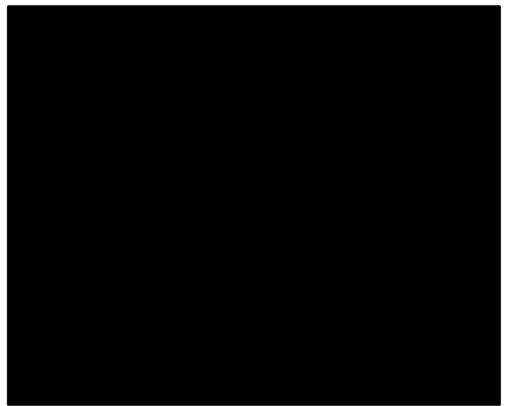

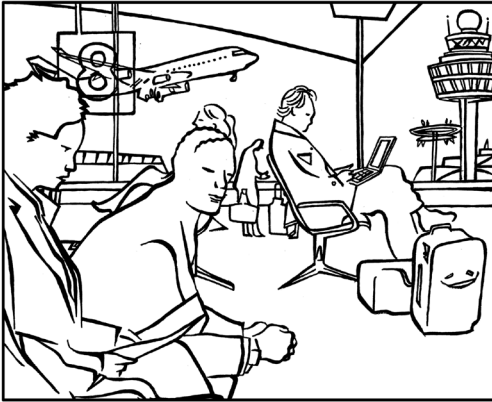

CHARLES DE GAULLE  
AIROPORT  
PARIS  
OCTOBER 2008

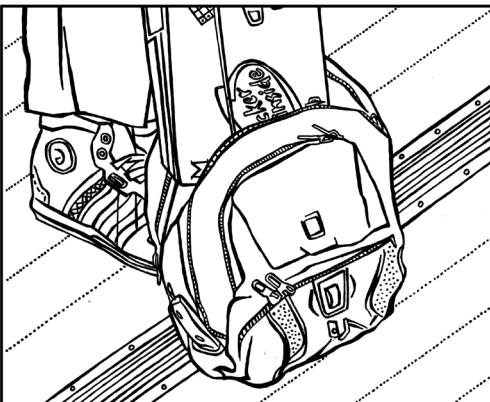

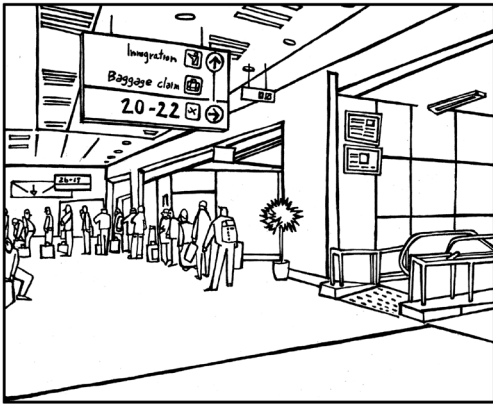

WE KNOW WHO YOU ARE SMART, KID

REALLY? WHO ARE YOU? HOW DO YOU KNOW MY NAME?

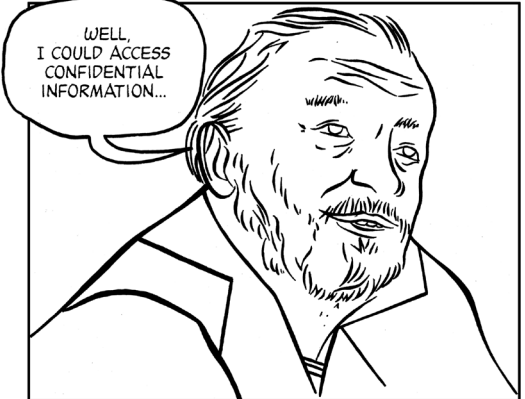

WELL, I COULD ACCESS CONFIDENTIAL INFORMATION...



OR I MIGHT HAVE PEEKED AT THE NAME ON THE TICKET.

Time	Airline	Fl.	Gate	Remarks
23:45	ZZ			244A
23:50	JET AIRWAYS		25	
23:51	QATAR		22	
00:35	Jet Air		21	
00:40	Qatar		8	
00:40	Qatar		11	
00:40	AD		3	
00:40	R		0	
00:45	Qatar		0	
00:50	Qatar		2	
			07	



WE COULD BE TWO STRANGERS MEETING IN AN INTERNATIONAL AIRPORT OR...

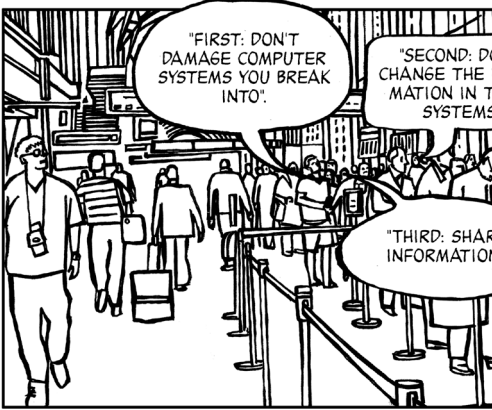

"FIRST. DON'T DAMAGE COMPUTER SYSTEMS YOU BREAK INTO".

"SECOND. DON'T CHANGE THE INFORMATION IN THOSE SYSTEMS".

"THIRD. SHARE INFORMATION".



I... I WROTE THOSE RULES... YEARS AGO.

IT IS YEARS SINCE I USED THAT NICKNAME.



HOPE I GOT YOUR ATTENTION NOW. OF COURSE, IF YOU ARE MENDAX.



ME AND YOU HAVE ALREADY MET SOMEWHERE IN THE NET.

IT LOOKS TO ME LIKE MOVIE CRAP.

BUT I WANTED TO SEE YOUR FACE.

THERES WORK TO DO, JULIAN, AND LETS SEE IF YOU'RE THE RIGHT PERSON FOR IT.

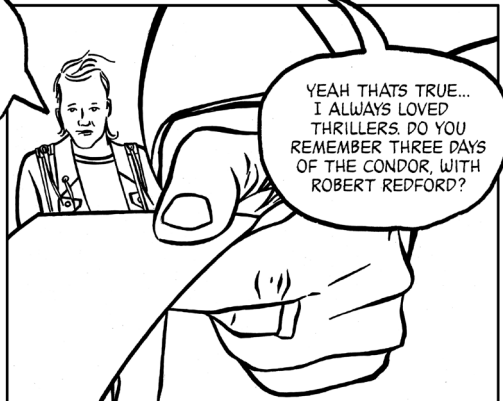

YEAH THATS TRUE... I ALWAYS LOVED THRILLERS. DO YOU REMEMBER THREE DAYS OF THE CONDOR, WITH ROBERT REDFORD?



OF COURSE.

GREAT MOVIE.  
GREAT OPENING  
SCENE.



HOLLYWOOD  
DOESNT  
DO THOSE KINDS  
OF MOVIES  
NOWADAYS.

I DONT AGREE.  
I THINK THEY DO EVEN  
MORE DISTURBING  
MOVIES NOW.  
ITS PEOPLE  
THAT ARE  
INSENSITIVE.



UHMMM...

ITS A DIFFICULT WORLD.  
JULIAN. WE ARE NO LONGER  
IN THE SEVENTIES. A LOT  
OF US JUST BECAME  
THE DEMONS WE FOUGHT  
WHEN WE WERE YOUNG.

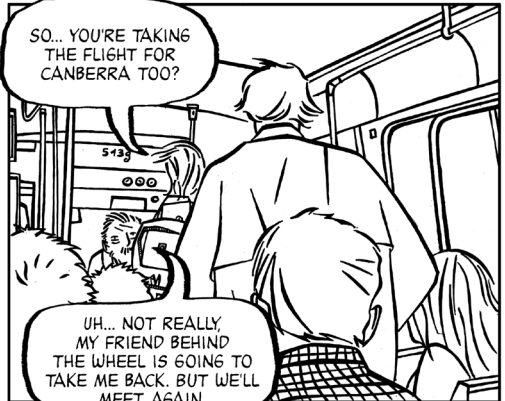

SO... YOU'RE TAKING  
THE FLIGHT FOR  
CANBERRA TOO?

UH... NOT REALLY,  
MY FRIEND BEHIND  
THE WHEEL IS GOING TO  
TAKE ME BACK. BUT WE'LL  
MEET AGAIN.

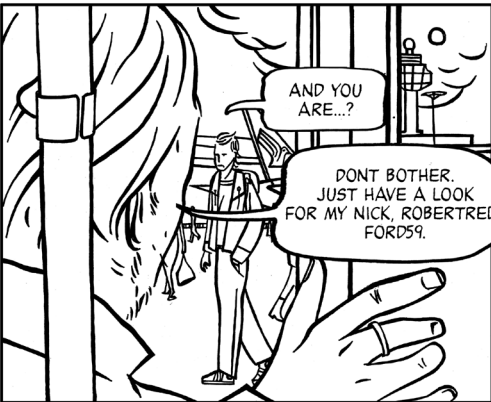

AND YOU  
ARE...?

DONT BOTHER.  
JUST HAVE A LOOK  
FOR MY NICK, ROBERTRED  
FORD59.



ROBERTREDFORD..?

YEAH,  
MY AVATAR IS  
AN HOURGLASS.

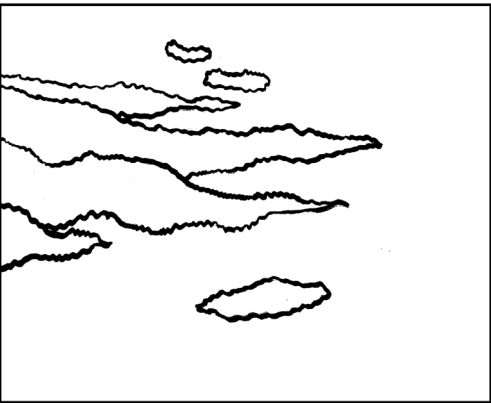
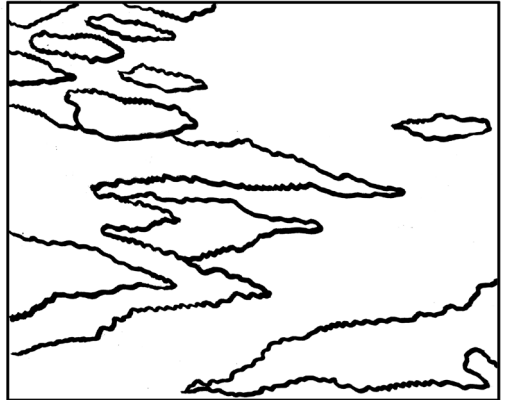
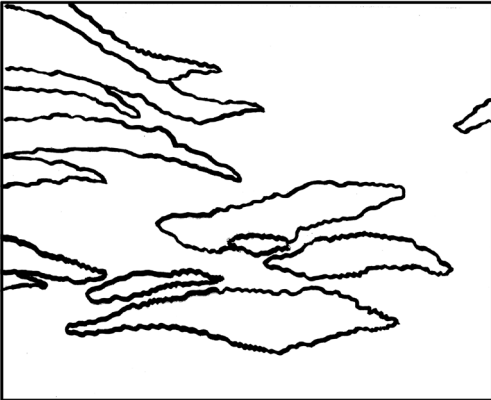
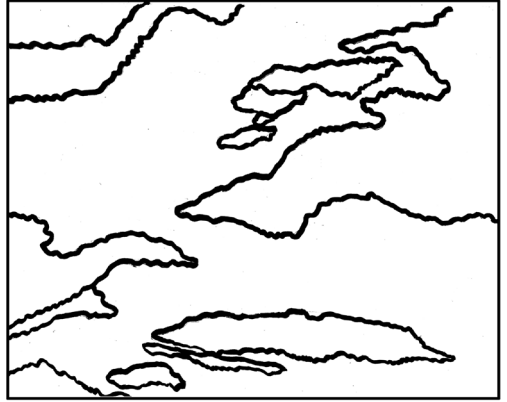
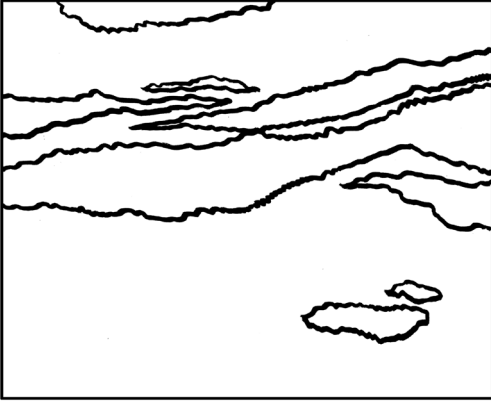

To radically shift regime behavior we must think clearly and boldly for if we have learned anything, it is that regimes do not want to be changed....]

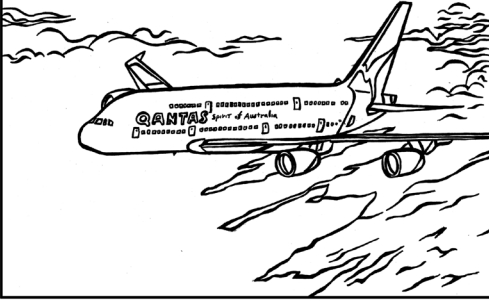

We must think beyond those who have gone before us, and discover technological changes...]

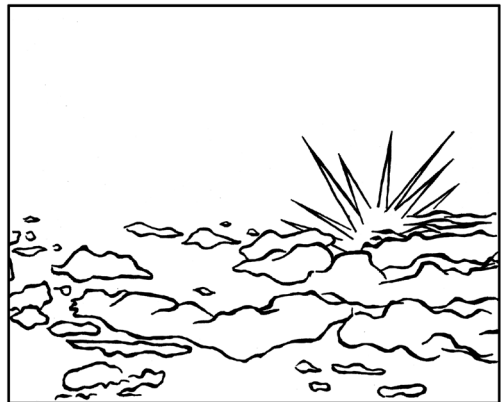
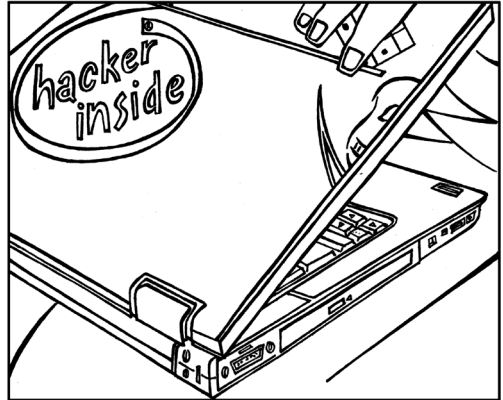
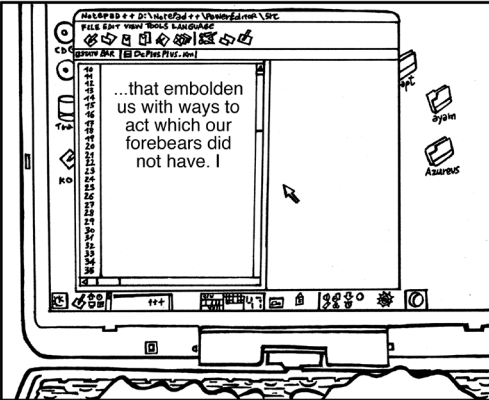





**WIKILEAKS  
PRESS CONFERENCE  
APRIL 2010**  
Spokesman: Julian Assange



T05S  
06:24:40 Z 21 24 29] 33 M 3

3TV **BUDDA**  
**BUDDA BUDDA**

CRAZYHORSE  
CONFIRM HOSTILES  
ELIMINATION.

NOT  
CONFIRMED

TADS 92 n.0.7 RECORDING

T05S  
06:26:33 Z E 12 15 187 1 24 W

3TV

CRAZYHORSE  
CONFIRM  
HOSTILES  
ELIMINATION

THERE IS TOO MUCH SMOKE HERE...  
OK IT'S CLEARING NOW...

TADS 68 459 RECORDING

T05S  
08:26:33 Z E

3TV

GROUND TROOPS THERE  
IN TEN MINUTES... CONFIRM  
THE SAFETY OF THE AREA...

YOU CAN BET IT BUSHMASTER.  
NOT EVEN ONE BASTARD IS STILL ALIVE!

TADS 461 RECORDING

T05S  
08:27:13 Z

3TV

GREAT JOB.  
CRAZYHORSE WAIT  
FOR GROUND TROOPS.  
ALL RIGHT.

ROGER.  
WAITING FOR GROUND  
TROOPS.

TADS RECORDING

CRAZYHORSE  
ASSURE COVER  
FIRE.

ROGER.





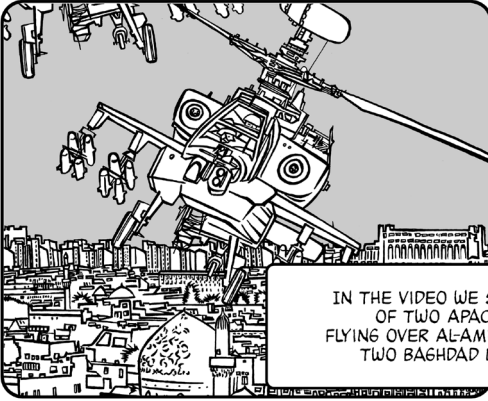

IN THE VIDEO WE SEE CAMERA SHOTS OF TWO APACHE HELICOPTERS FLYING OVER AL-AMIN AND ALTHANIYAH, TWO BAGHDAD NEIGHBORHOODS.



THE RECORDED VOICES ARE THE PILOTS. THEY CONTACT THEIR HEADQUARTERS AND AWAIT FOR INSTRUCTIONS. WE HEAR THEM IDENTIFY SOME PEOPLE ON THE ROAD AS GUERRILLA FIGHTERS.

THEY ASK AND OBTAIN PERMISSION TO FIRE. THE FINAL RESULT IS 18 DEAD AND TWO KIDS MIRACULOUSLY JUST WOUNDED.

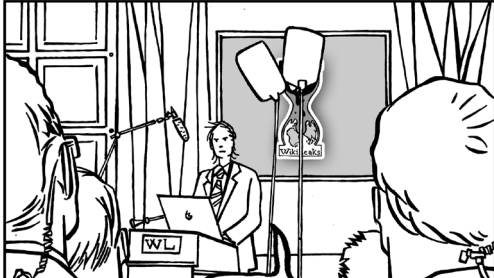

THESE MEN WERE NOT INSURGENTS TWO OF THEM WERE REUTERS JOURNALISTS.

SAEED CHMAGH AND NAMIR NOOR-ELDINE, NADIR'S CAMERA WAS MISTAKEN FOR A WEAPON BY THE PILOTS.



NONE OF THE KILLED WAS ARMED.



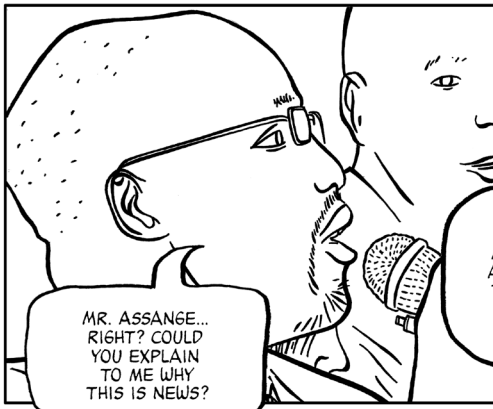

MR. ASSANGE...  
RIGHT? COULD  
YOU EXPLAIN  
TO ME WHY  
THIS IS NEWS?

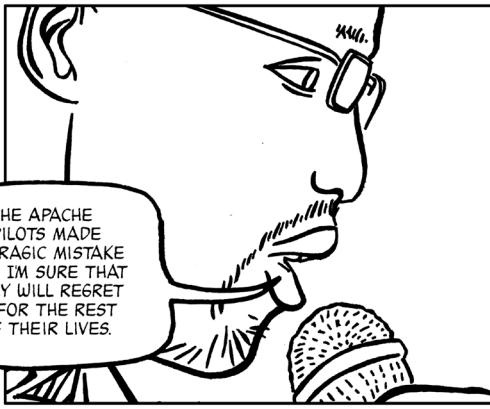

THE APACHE  
PILOTS MADE  
A TRAGIC MISTAKE  
AND I'M SURE THAT  
THEY WILL REGRET  
IT FOR THE REST  
OF THEIR LIVES.

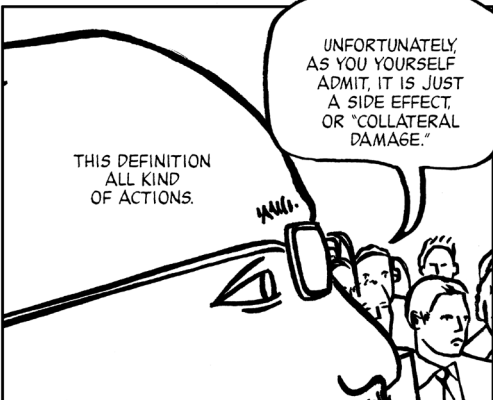

THIS DEFINITION  
ALL KIND  
OF ACTIONS.

UNFORTUNATELY  
AS YOU YOURSELF  
ADMIT, IT IS JUST  
A SIDE EFFECT,  
OR "COLLATERAL  
DAMAGE."



WE CALLED THE VIDEO  
'COLLATERAL DAMAGE'  
BECAUSE THE US ARMY  
AND THE MEDIA LOVE  
TO US THIS TERM  
FOR UNPLANNED COSTS  
& CASUALTIES  
OF WAR.



BUT  
IT'S TRUE,  
IT WAS  
COLLATERAL  
DAMAGE.

THE PILOTS  
WERE  
CONTINUOUSLY  
ASKING  
PERMISSION  
TO FIRE.

I KNOW  
FOR SURE THAT  
THE WOUNDED KIDS  
WERE TREATED  
BY AMERICAN  
DOCTORS.



WHY DO YOU  
HATE DEMOCRACY?

WHO  
IS PAYING  
YOU?

WHERE  
DO YOU  
GET THE  
MONEY  
FROM?

ARE YOU  
PAYED BY  
RUSSIANS?

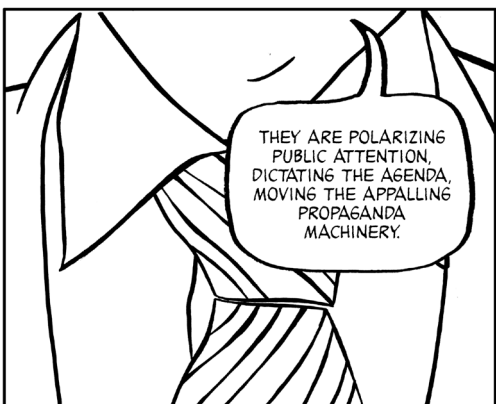



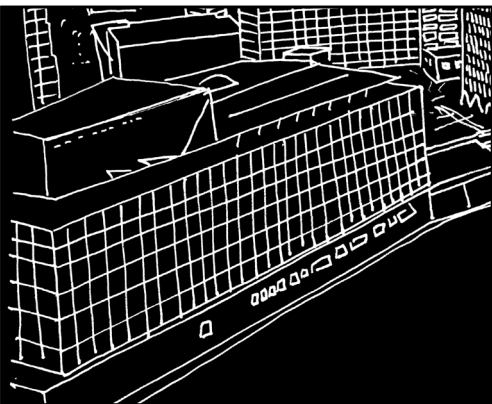

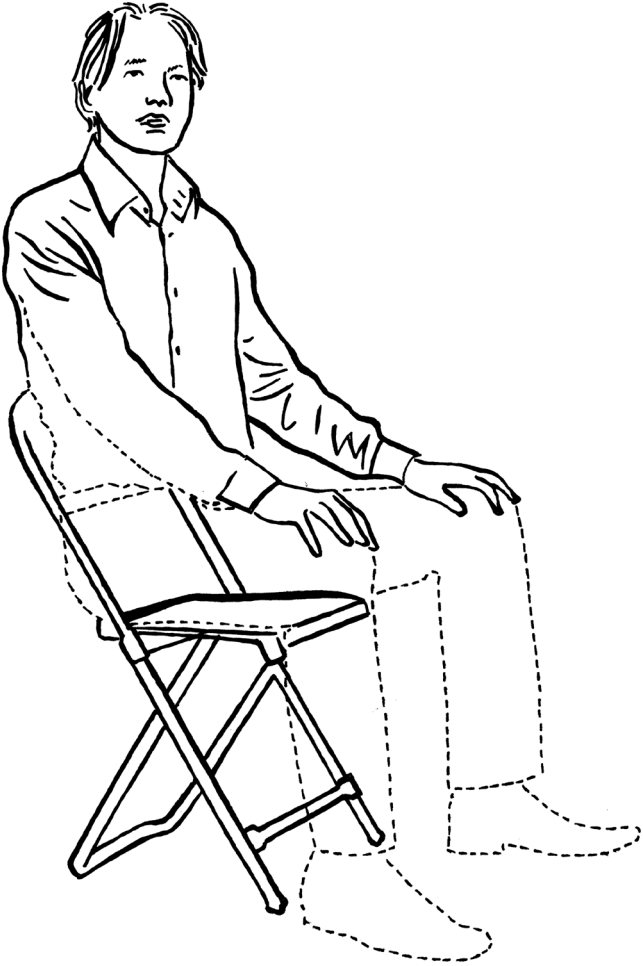



«But such is the irresistible nature of  
truth, that all it asks,  
and all it wants,  
is the liberty of appearing».  
**Thomas Paine**

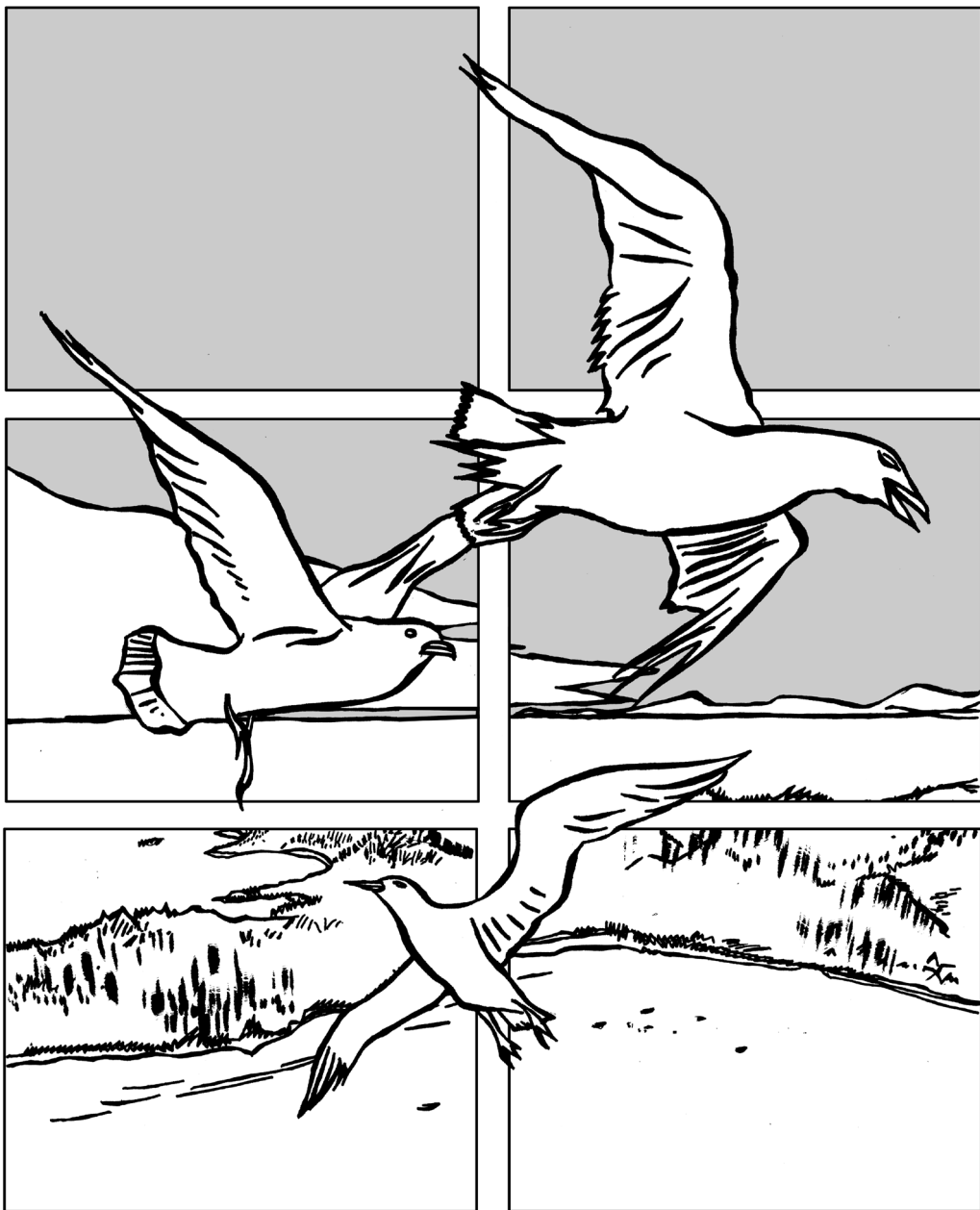

1983.  
Magnetic Island,  
Townsville, Australia



*« We have a little visitor,  
He comes to us at night »*

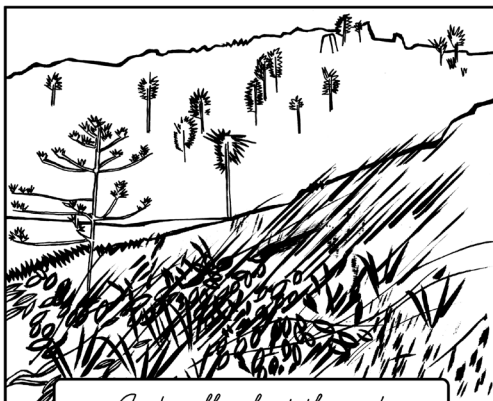

*« And walks about the garden  
When the moon is shining bright. »*



*« I'm sure I saw him here!  
I think I see him there! »*

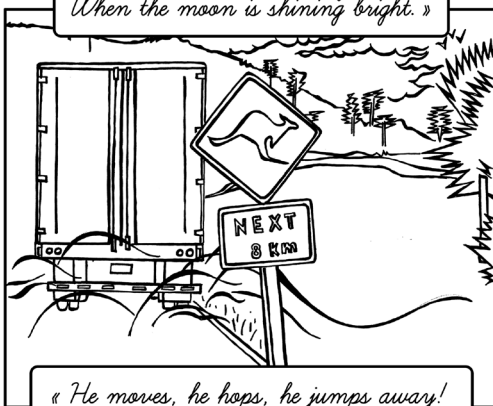

*« He moves, he hops, he jumps away!  
A little grey bandicoot. »*



« We send no invitation,  
We do not bid him come ».



« When Mother rakes the borders clean,  
And makes them trim and neat ».



« When Father plants a fruit-tree rare  
And treads the earth around ».

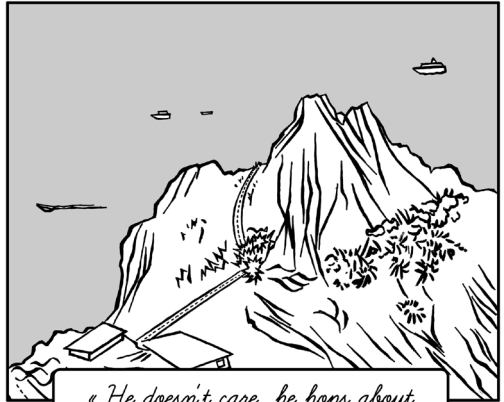

« He doesn't care, he hops about  
As if he were at home ».



« He writes a little pattern  
Upon them with his feet ».



« He nibbles at the tiny roots  
And pulls them from the ground ».

« Sometimes we hear his chattering call,  
And then we slyly creep ».

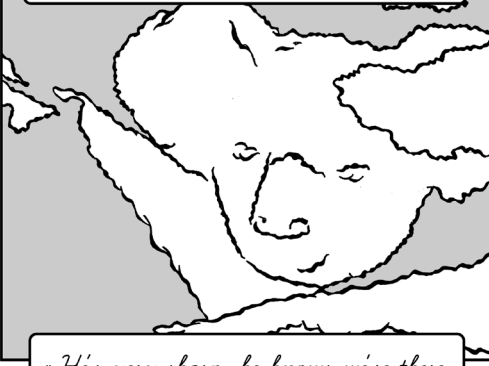

« He's very sharp, he knows we're there,  
Although we make no noise ».



« And hide behind a bush or tree  
To try to get a peep ».

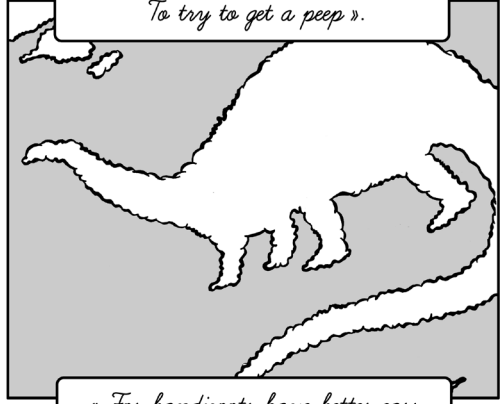

« For bandicoots have better ears  
Than little girls and boys ».



« So while we stand and gaze around,  
Someone is sure to say ».

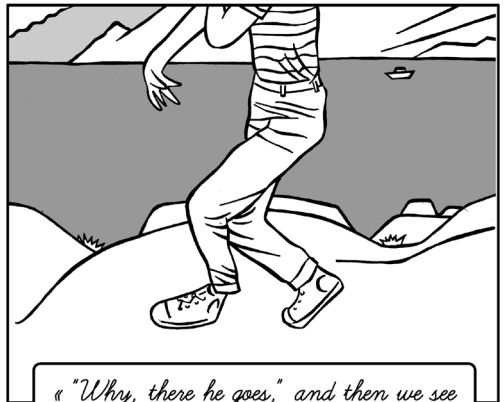

« "Why, there he goes," and then we see  
He's hopping far away ».

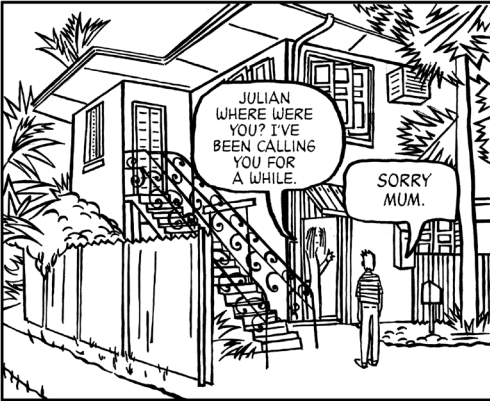



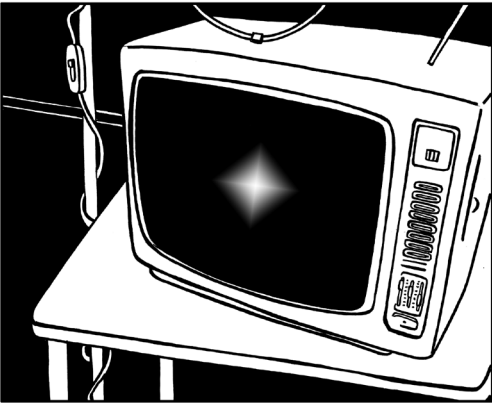
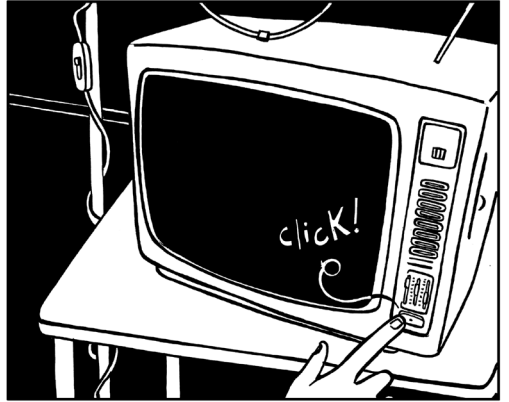
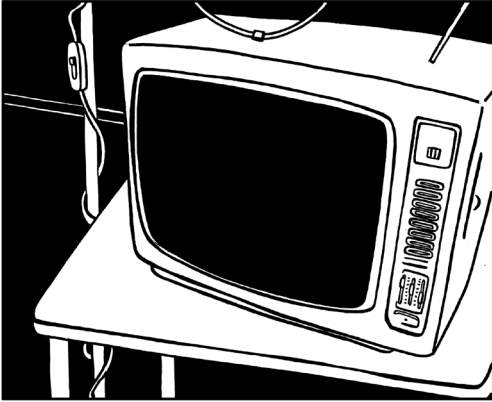

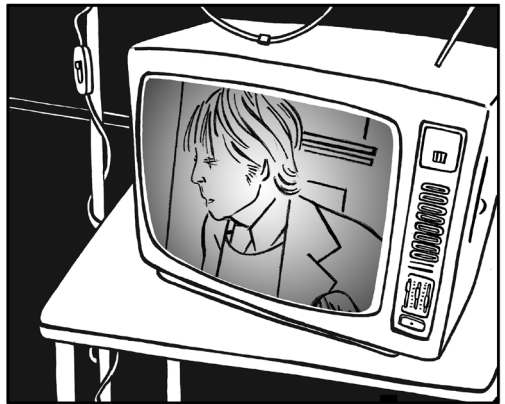
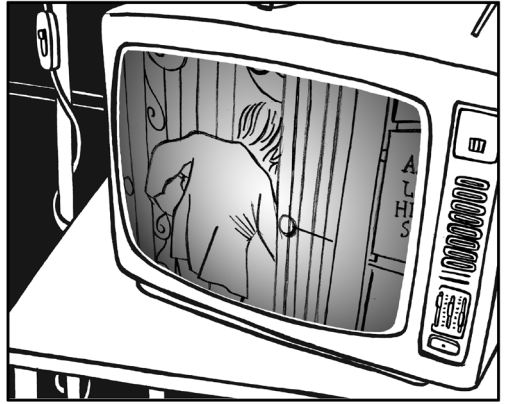

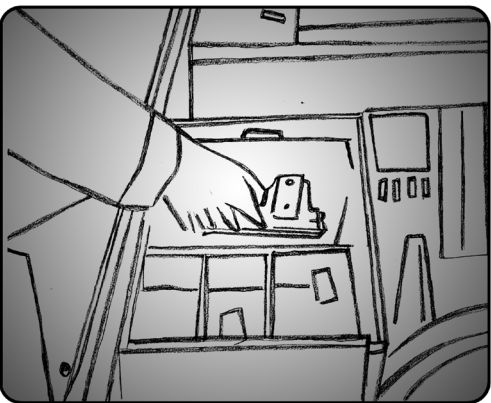
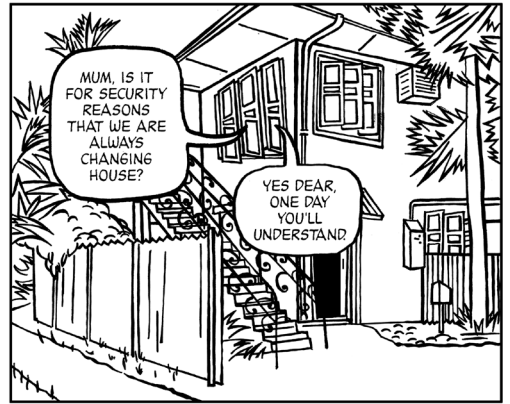

A contemporary 1970s anti-CIA movie, *Three Days of the Condor*, on T.V.

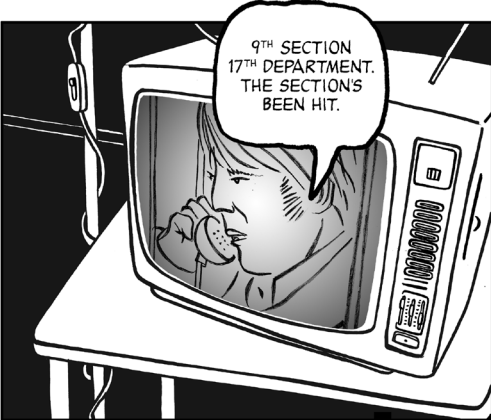
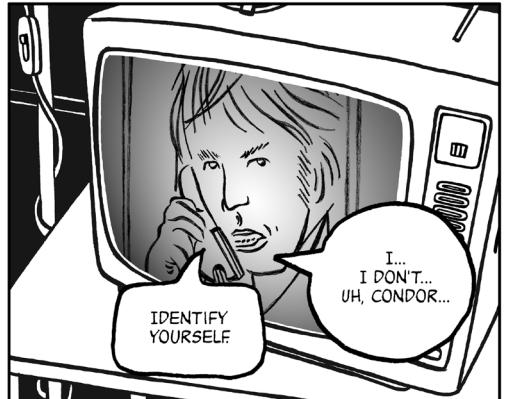
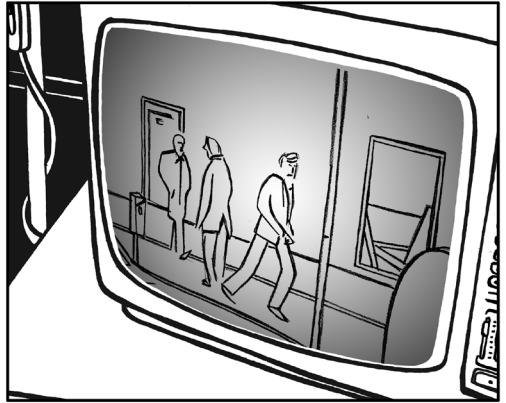

1991

The home of Assange and his wife and child, in Melbourne, Australia



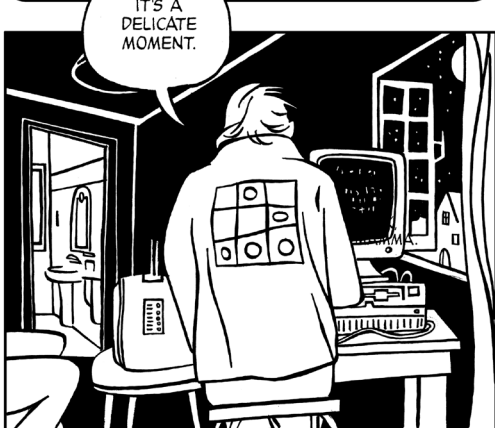

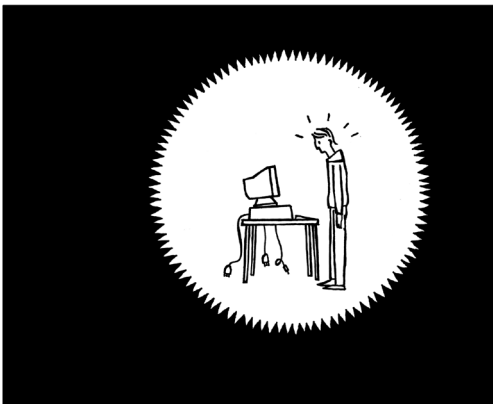
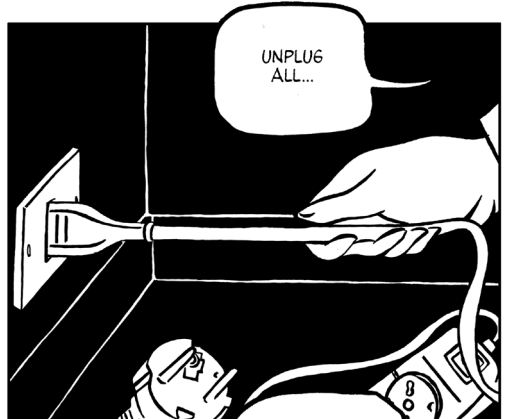
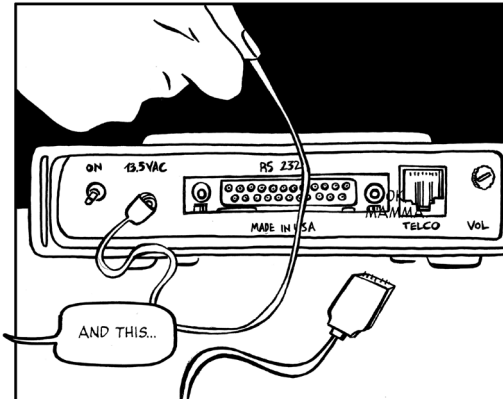
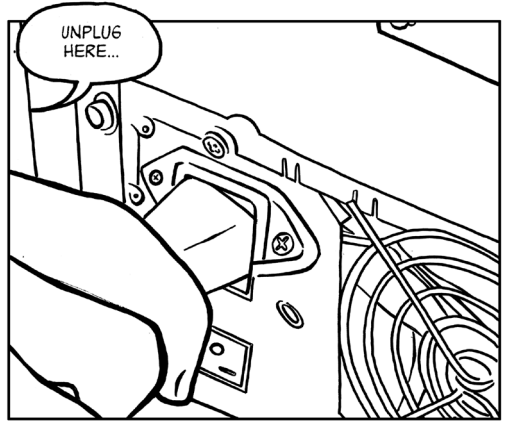
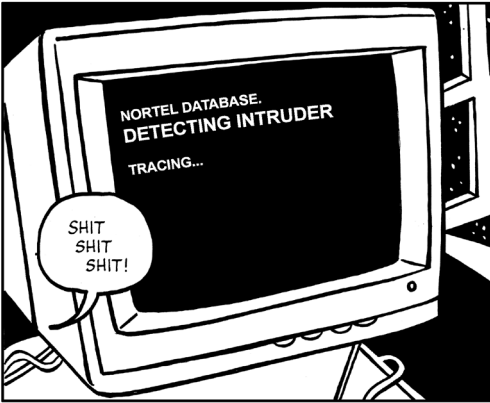

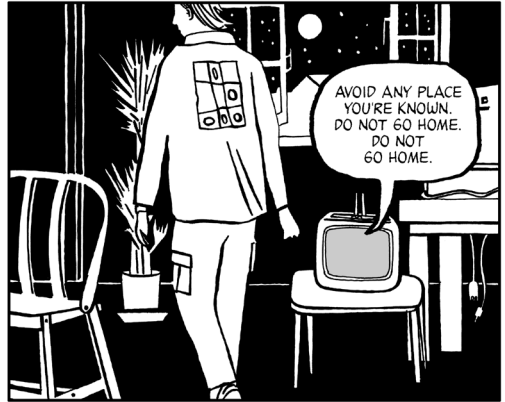



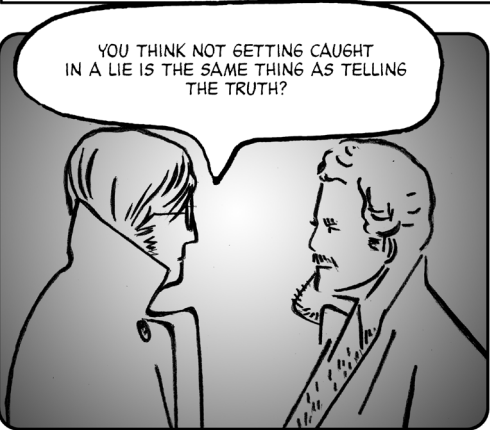
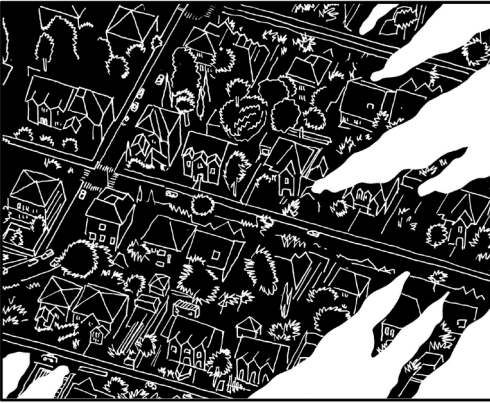

YOU THINK NOT GETTING CAUGHT IN A LIE IS THE SAME THING AS TELLING THE TRUTH?

NO. IT'S SIMPLE ECONOMICS. TODAY IT'S OIL, RIGHT?

POLICE!

WE ARE LOOKING FOR MR. ASSANGE.

JULIAN ASSANGE.



WANT TO KNOW  
SOMETHING? THEY  
WON'T WANT US TO  
ASK THEM. THEY'LL  
WANT US TO GET  
IT FOR THEM.

THERE WERE  
SEVEN PEOPLE  
KILLED,  
HIGGINS.

THE  
COMPANY  
DIDN'T  
ORDER IT.

SEVEN PEOPLE KILLED, AND YOU  
PLAY FUCKING GAMES!

RIGHT. AND THE OTHER  
SIDE DOES, TOO. THAT'S  
WHY WE CAN'T LET YOU  
STAY OUT SIDE.

WHAT?

YOU KNOW WHERE  
WE ARE. JUST LOOK  
AROUND THEY'VE GOT IT.  
THAT'S WHERE THEY  
SHIP FROM. THEY'VE  
GOT ALL OF IT.

WHAT?  
WHAT  
DID YOU DO?

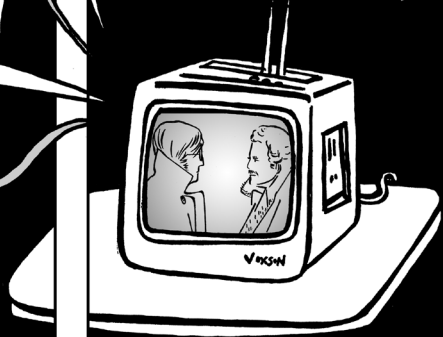

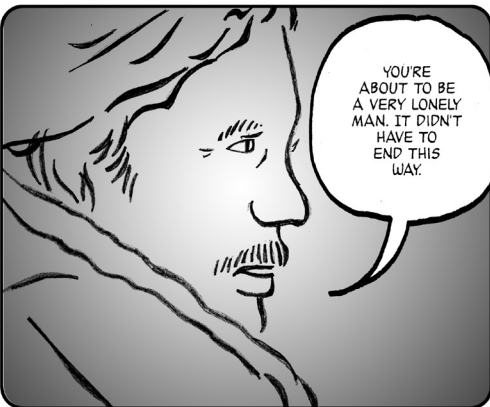
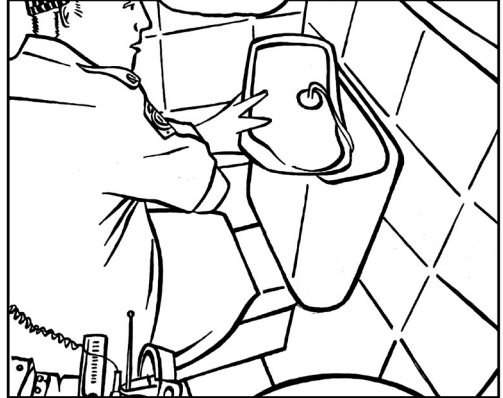

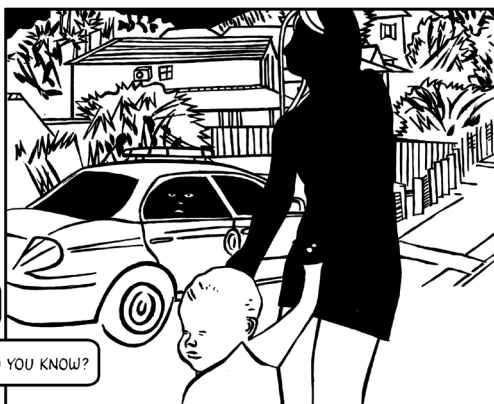
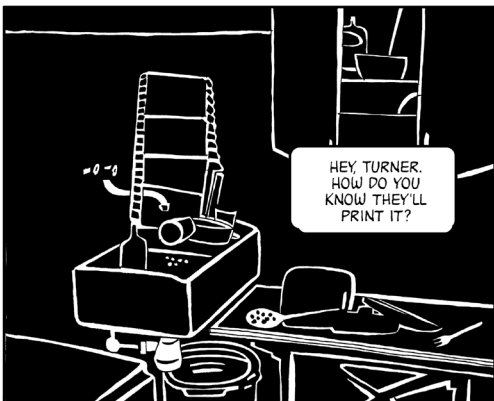
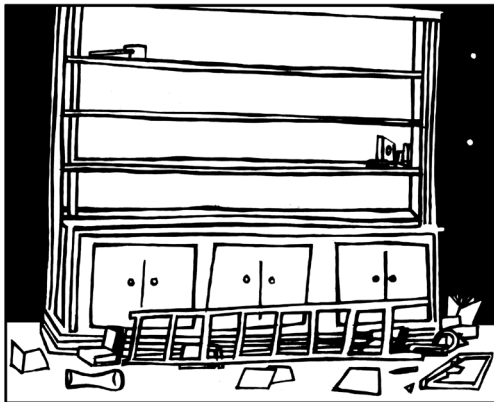

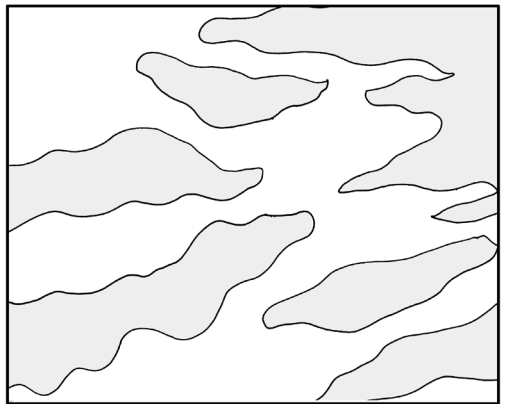
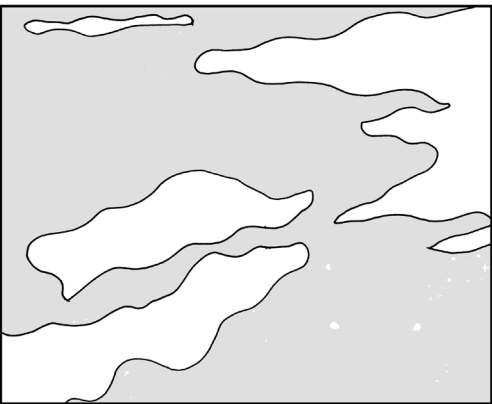
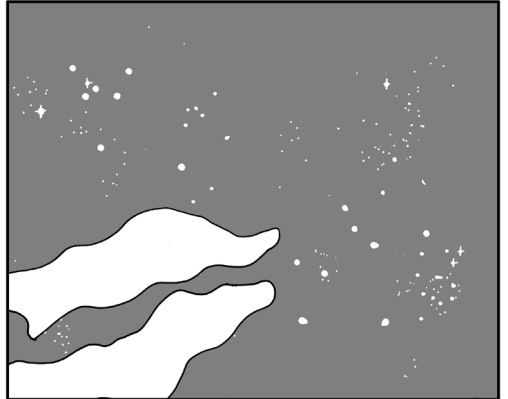
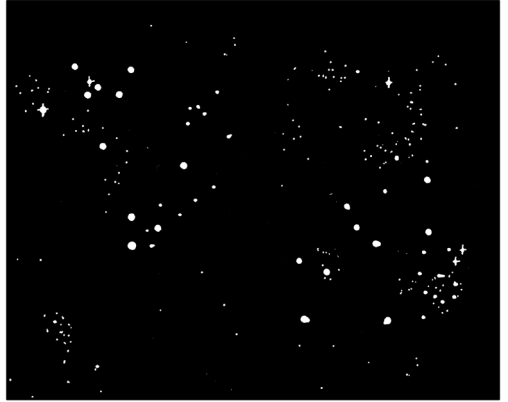

**1994**  
Melbourne Court

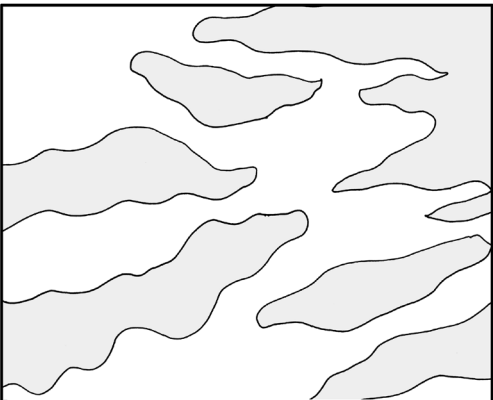
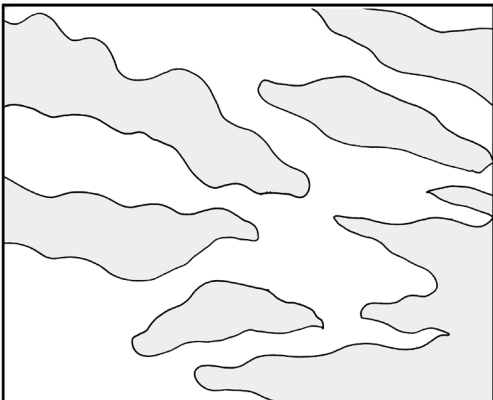
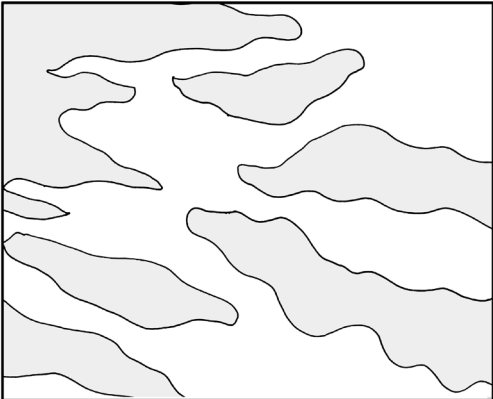
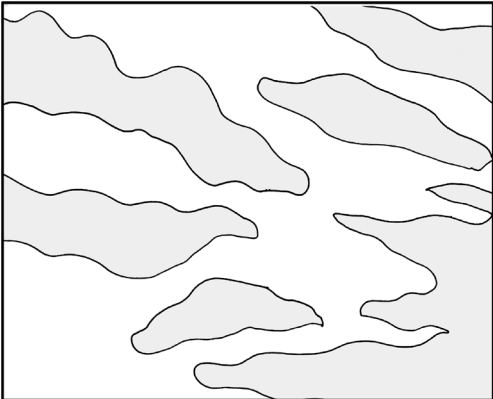
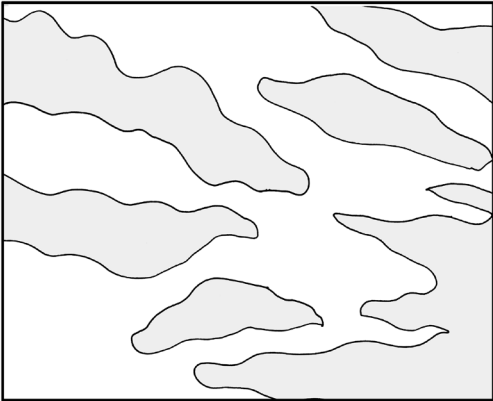

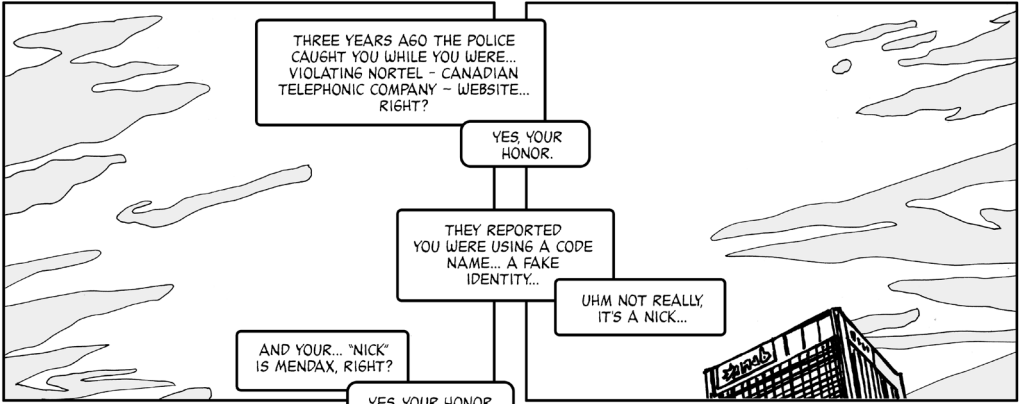

THREE YEARS AGO THE POLICE  
CAUGHT YOU WHILE YOU WERE...  
VIOLATING NORTEL - CANADIAN  
TELEPHONIC COMPANY - WEBSITE...  
RIGHT?

YES, YOUR  
HONOR.

THEY REPORTED  
YOU WERE USING A CODE  
NAME... A FAKE  
IDENTITY...

UHM NOT REALLY,  
IT'S A NICK...

AND YOUR... "NICK"  
IS MENDAX, RIGHT?

YES, YOUR HONOR,  
IT COMES FROM  
A MOCKERY  
OF ORAZIO.

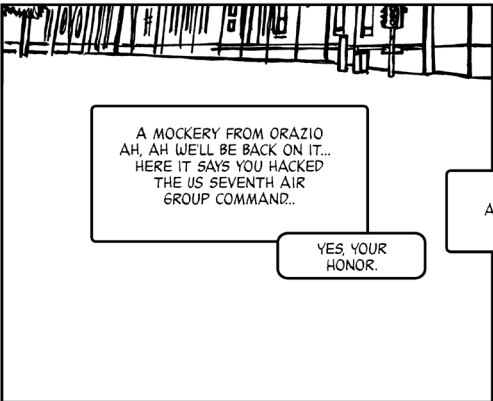
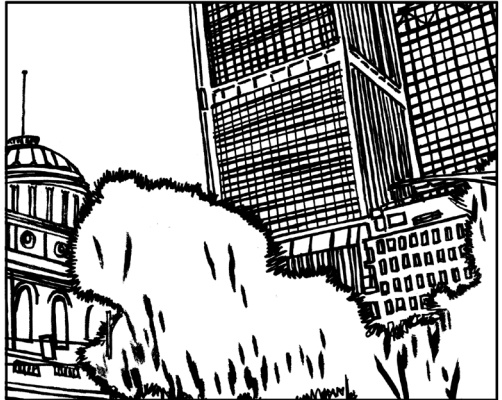
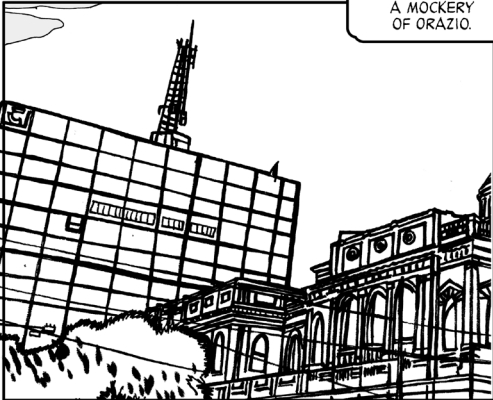

A MOCKERY FROM ORAZIO  
AH, AH WE'LL BE BACK ON IT...  
HERE IT SAYS YOU HACKED  
THE US SEVENTH AIR  
GROUP COMMAND..

YES, YOUR  
HONOR.



HERE WE HAVE A PRETTY LONG LIST OF YOUR HACKER  
ACTIVITIES.. I WAS SAID THAT NORTEL LOST 100,000 DOLLARS  
BECAUSE OF YOU. YOU MADE A HUGE DAMAGE.

NO, YOUR HONOR,  
TO DAMAGE IS NOT PART  
OF MY PHILOSOPHY.  
IM A HACKER.

YOUR PHILOSOPHY? TELL ME SOMETHING ABOUT IT.

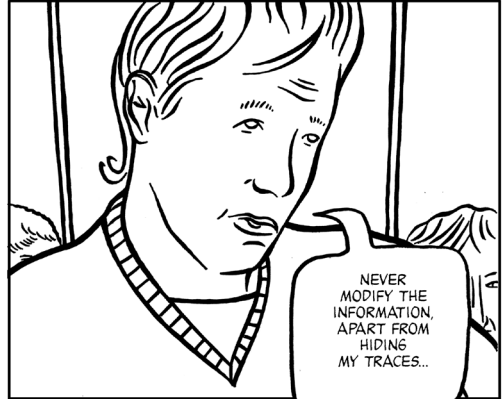
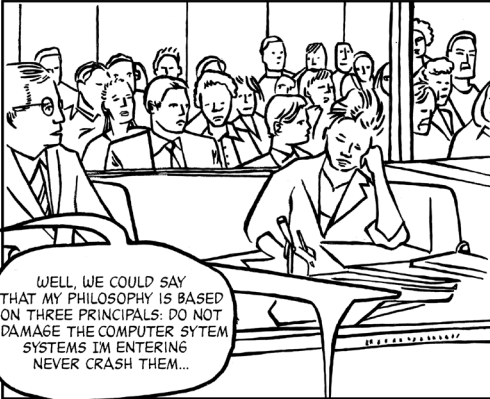

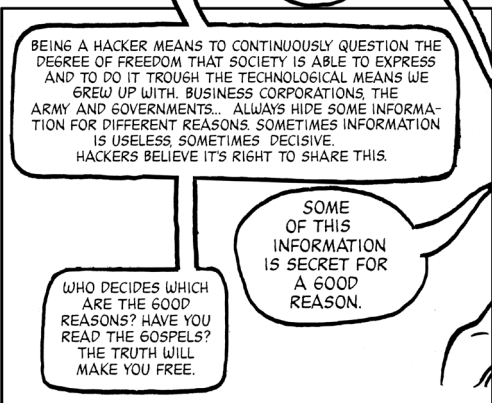
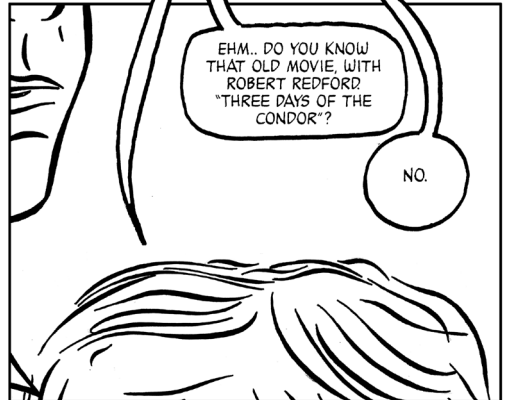

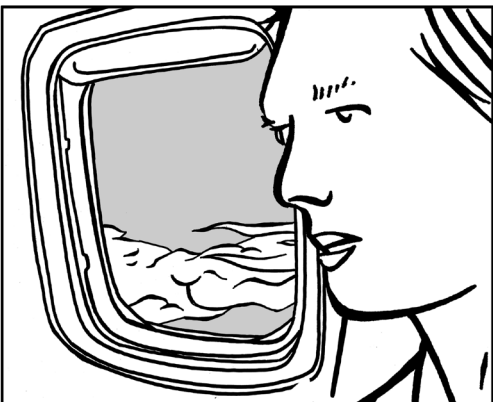
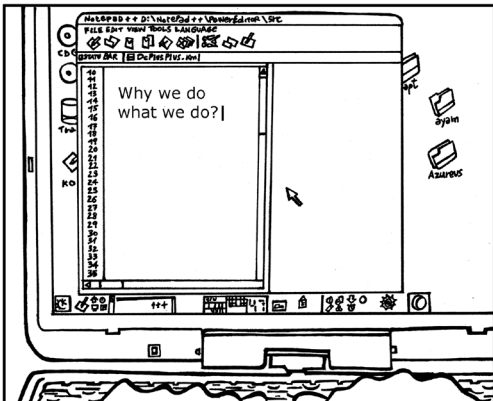
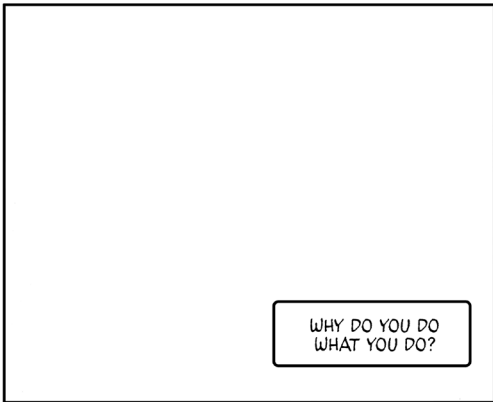

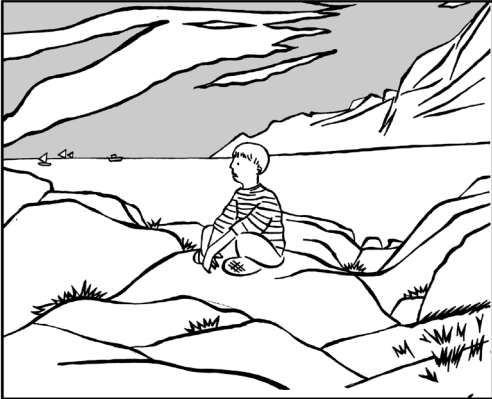
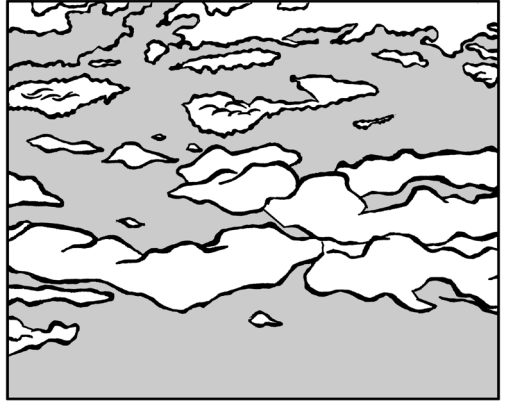

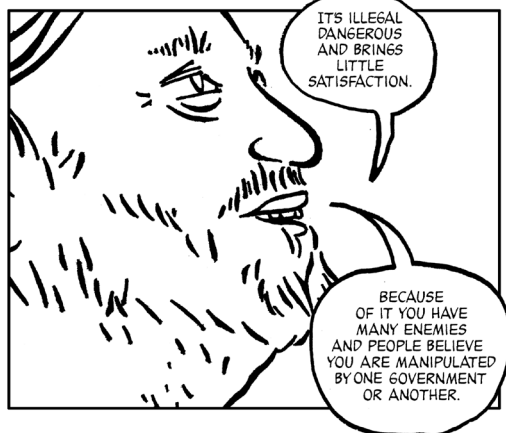
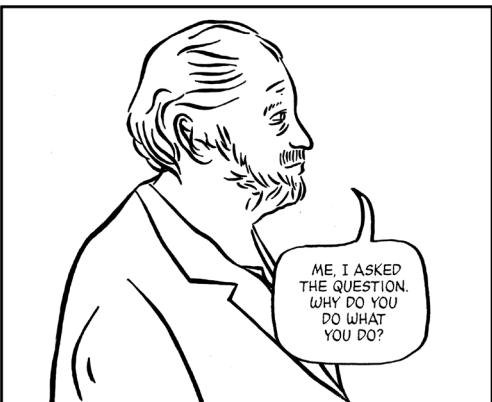

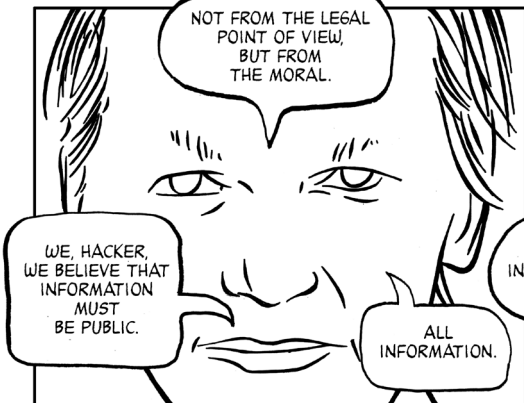

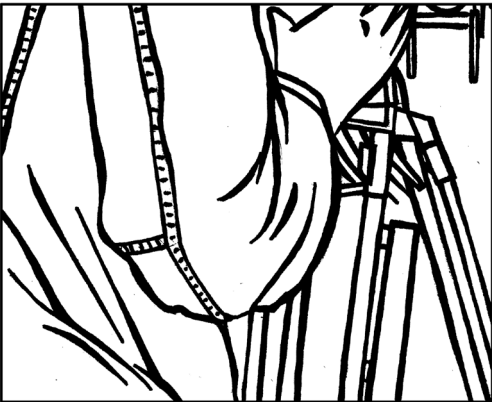
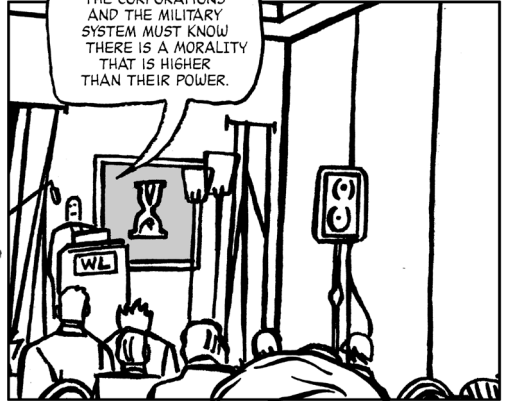
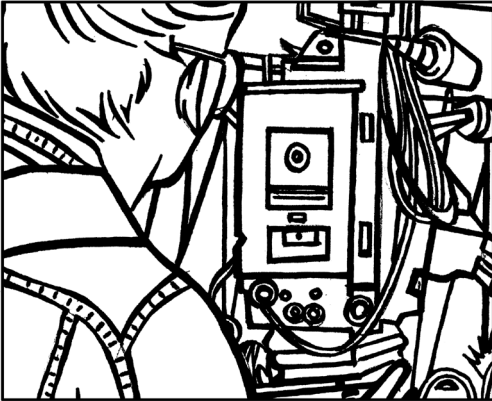
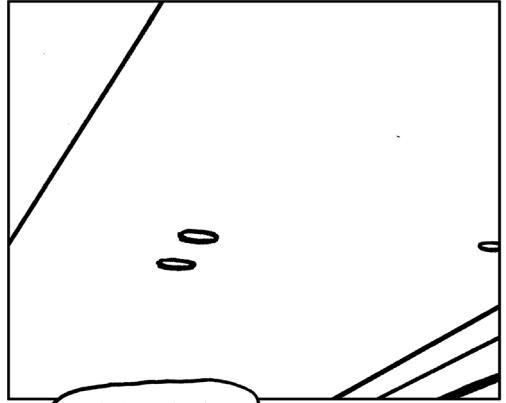
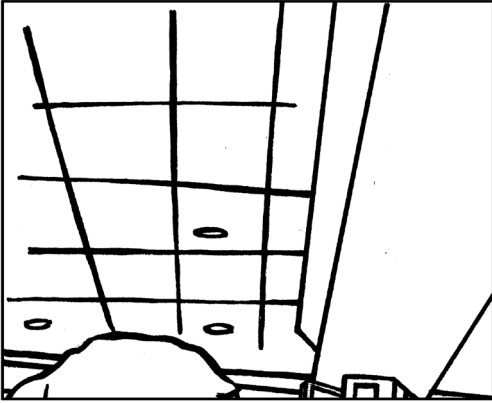



«My philosophy is usually:  
if I want to make things happen I'll just  
act first and apologize later».

**Shepard Fairey aka Obey**

Press conference  
APRIL 2010



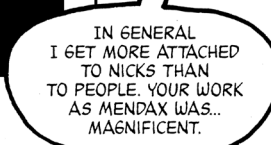
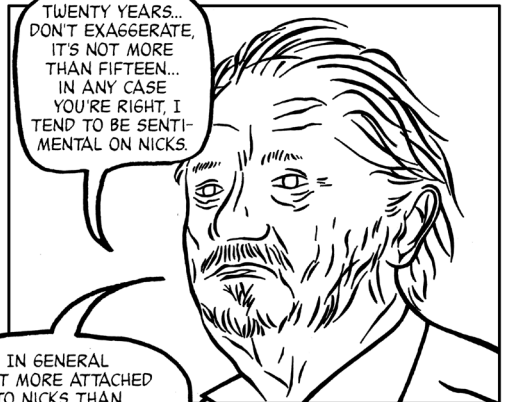



AHA!



THE ETHICAL HACKER PAR EXCELLENCE RIGHT? WHO CALSED YOU THAT?

CAN'T REMEMBER, BUT IT'S BULLSHIT ALL HACKERS FOLLOW ETHICS.

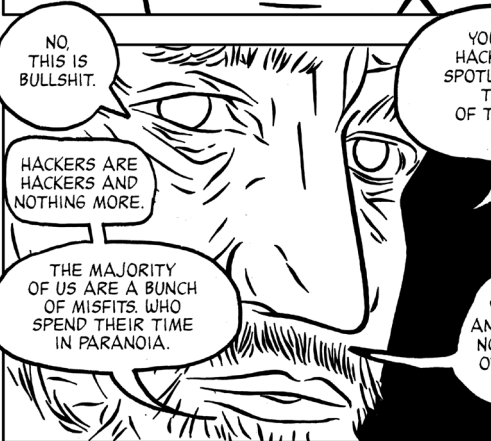

NO, THIS IS BULLSHIT.

HACKERS ARE HACKERS AND NOTHING MORE.

THE MAJORITY OF US ARE A BUNCH OF MISFITS WHO SPEND THEIR TIME IN PARANOIA.

YOU BROUGHT HACKERS IN THE SPOTLIGHT, PULLING THEM OUT OF THEIR CAVES.

I WAS NOT SO IMPORTANT.

YES YOU ARE, AND YOU KNOW IT. NOW THERE ARE OTHER ASPECTS TO STUDY.



WIKILEAKS HAS JUST PUBLISHED A VIDEO GIVING EVIDENCE THAT THE US ARMY SYSTEMATICALLY LIES AND VIOLATES US LAWS. YOU DEMONSTRATED THAT THE ARMY KILLS JOURNALISTS AND TRIES TO HIDE ITS TRACKS.

YOU'RE KIDDING, AREN'T YOU?



LIKE WHAT?



HERE COMES THE FUN PART.



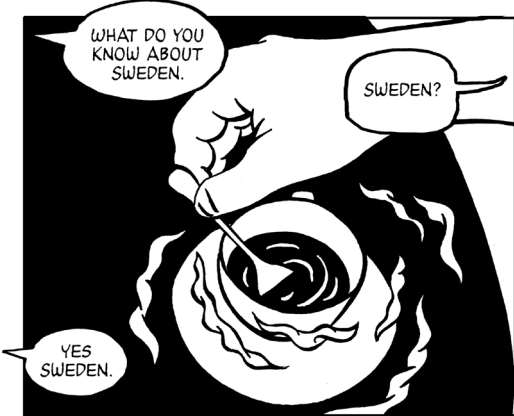



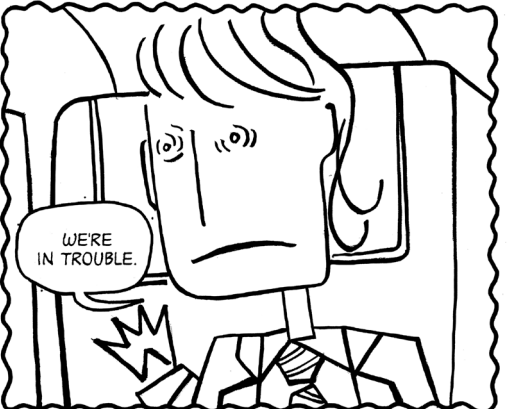
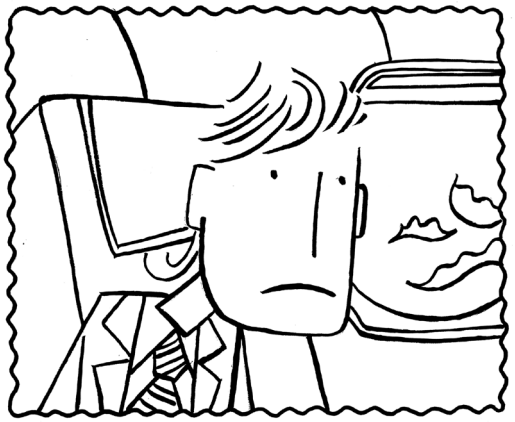
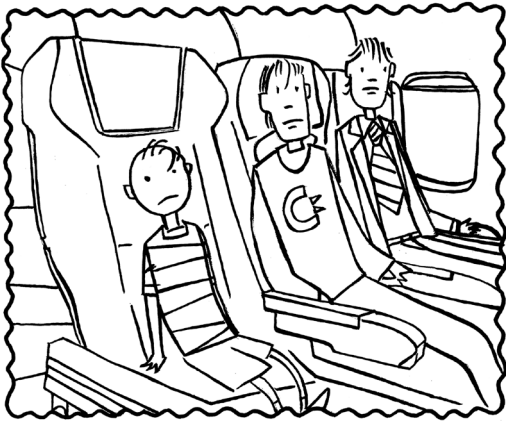

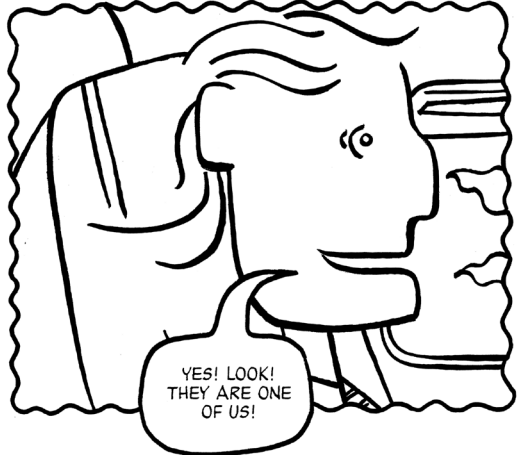
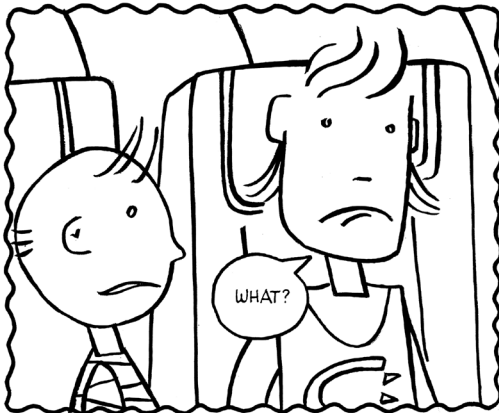
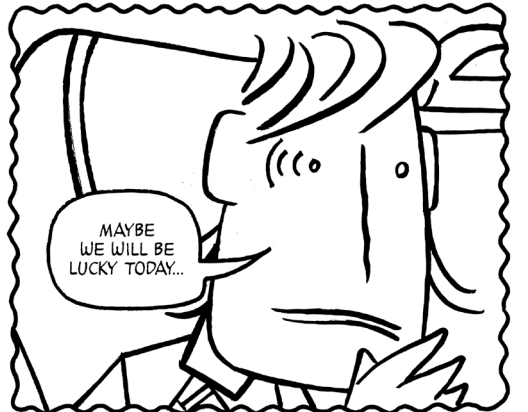

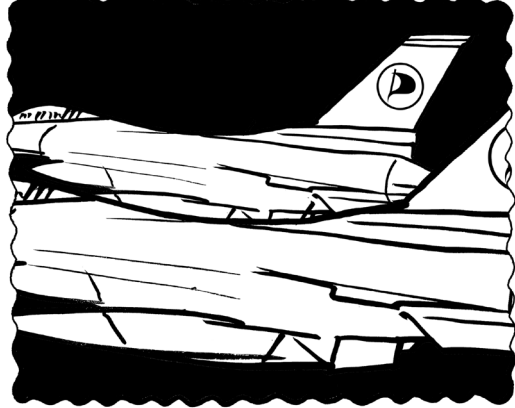
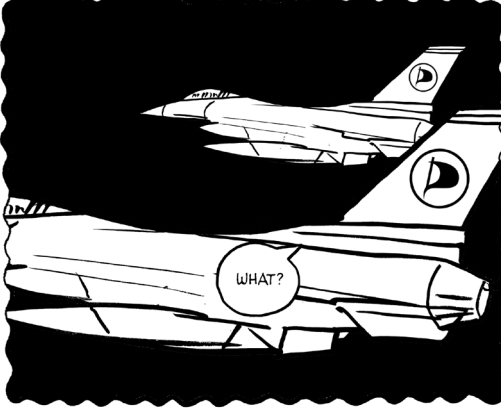

STOCKHOLM  
SEPTEMBER 2010

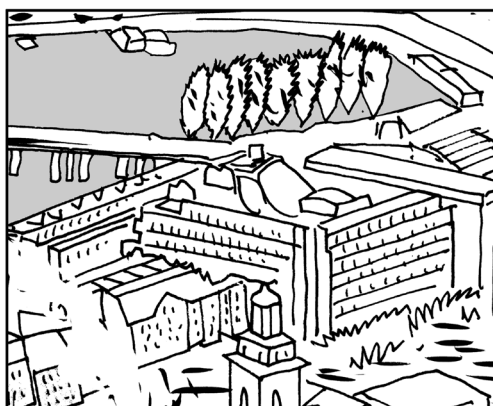
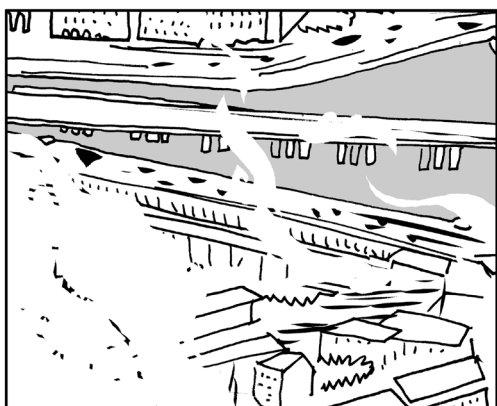
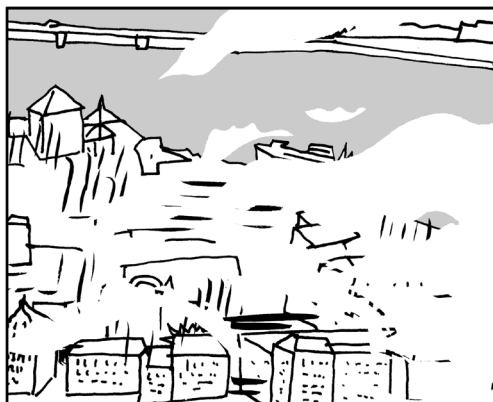
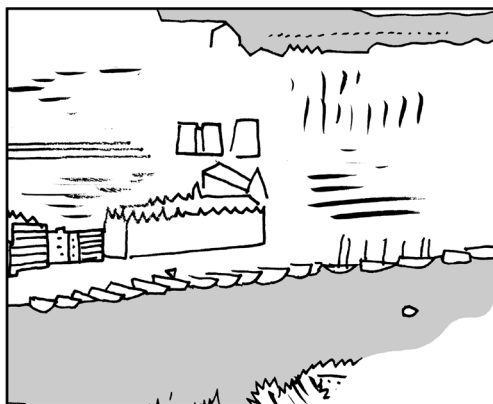

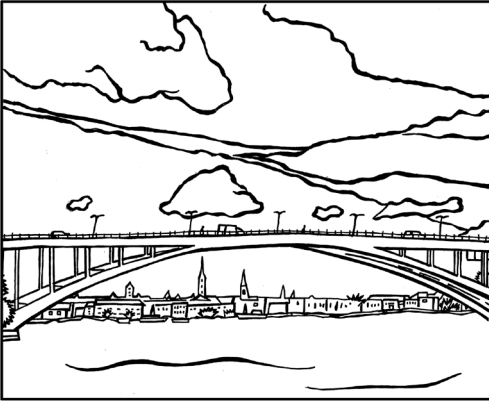

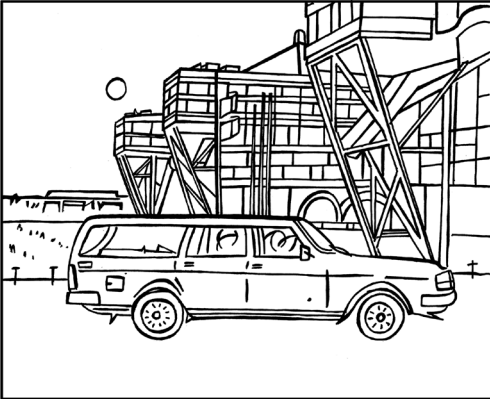

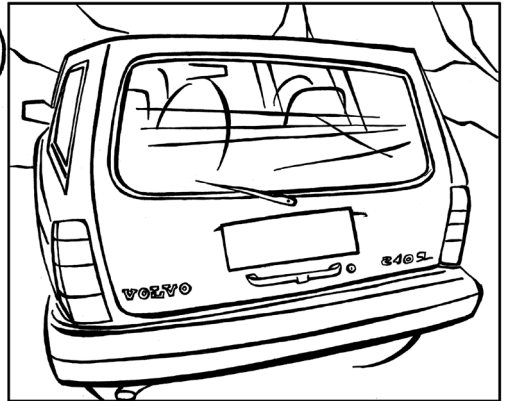
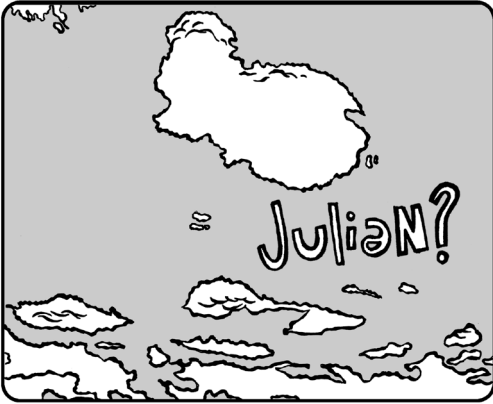

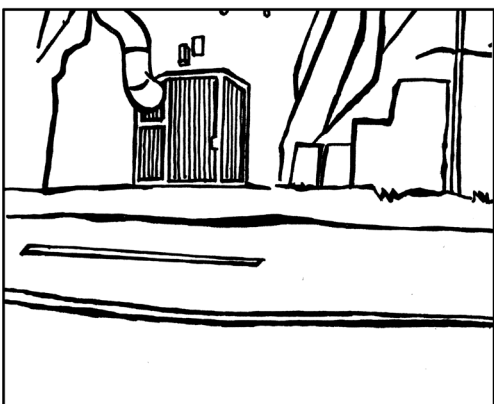
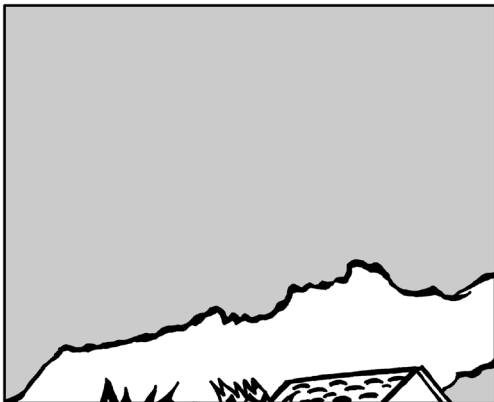

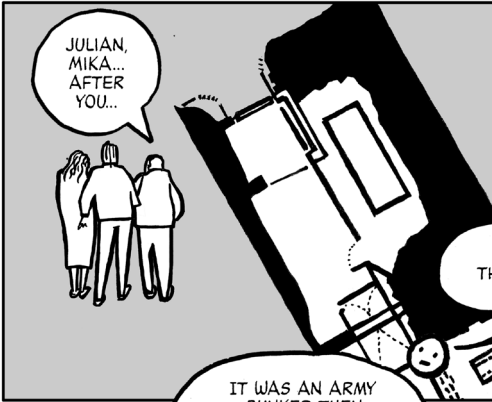

JULIAN,  
MIKA...  
AFTER  
YOU...

WHAT'S  
THIS PLACE?

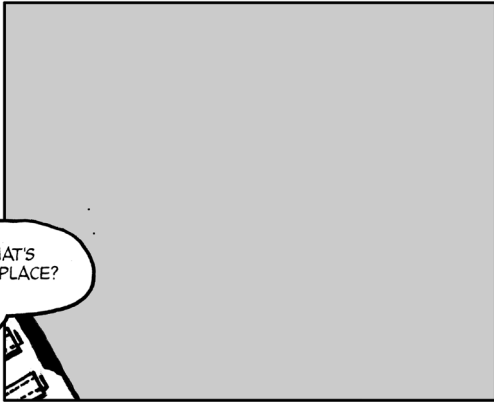

IT WAS AN ARMY  
BUNKER THEN  
IT WAS ACQUIRED  
BY BAHNOF A SWEDISH  
INTERNET PROVIDER.  
PIRATE PARTY.

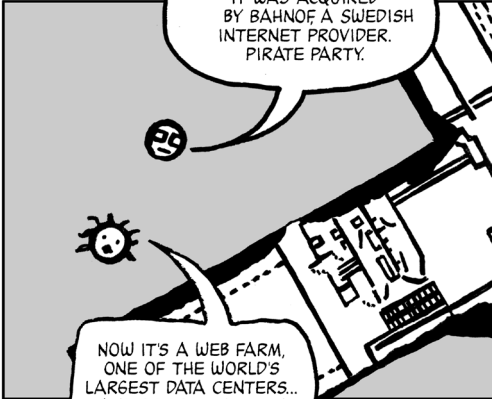

NOW IT'S A WEB FARM,  
ONE OF THE WORLD'S  
LARGEST DATA CENTERS...  
AND OBVIOUSLY IT'S IN  
VERY GOOD TERMS WITH  
THE PIRATE PARTY.

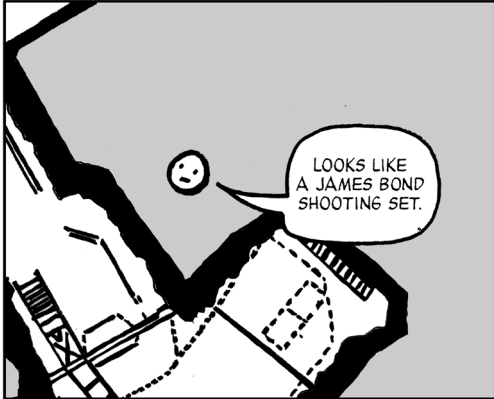

LOOKS LIKE  
A JAMES BOND  
SHOOTING SET.



WE THOUGHT  
THAT WIKILEAKS  
SHOULD  
BE SAFE.

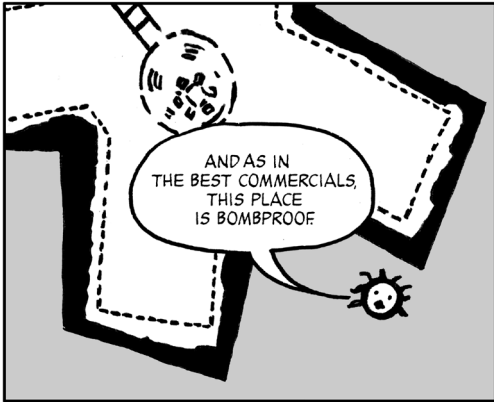

AND AS IN  
THE BEST COMMERCIALS,  
THIS PLACE  
IS BOMBPROOF

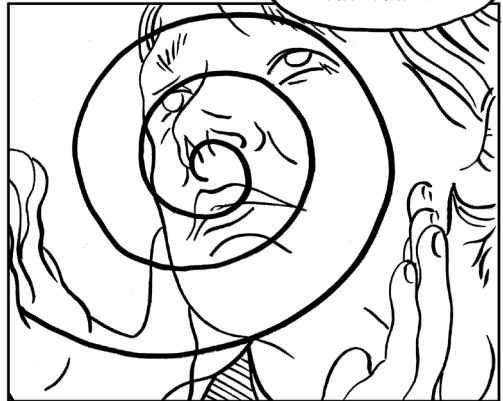

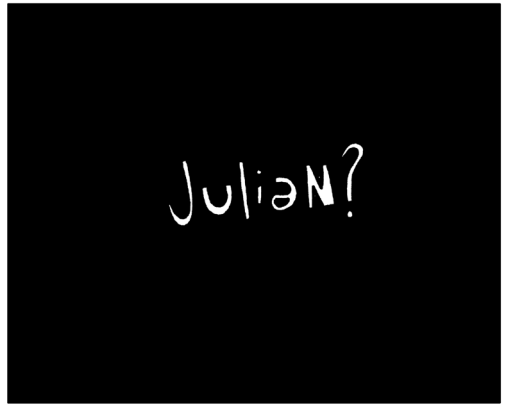

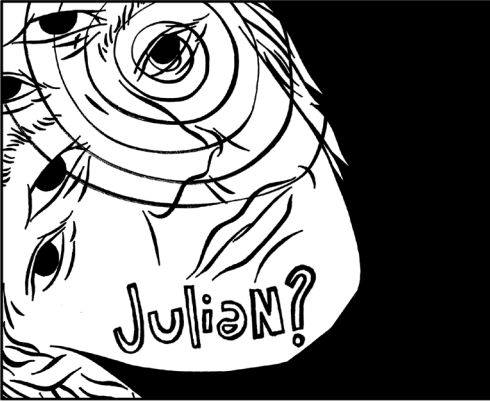



WHICH INTERVIEW?

OH IT'S NOTHING, DON'T WORRY ABOUT IT.

I'M TIRED, NOT DYING...

IT'S JUST THAT I WORK FOR... EHM... A POLITICAL REVIEW...

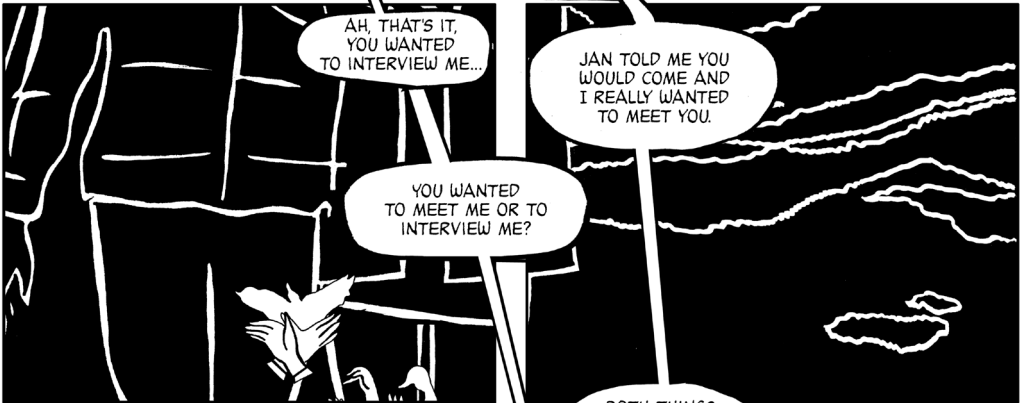

AH, THAT'S IT, YOU WANTED TO INTERVIEW ME...

JAN TOLD ME YOU WOULD COME AND I REALLY WANTED TO MEET YOU.

YOU WANTED TO MEET ME OR TO INTERVIEW ME?

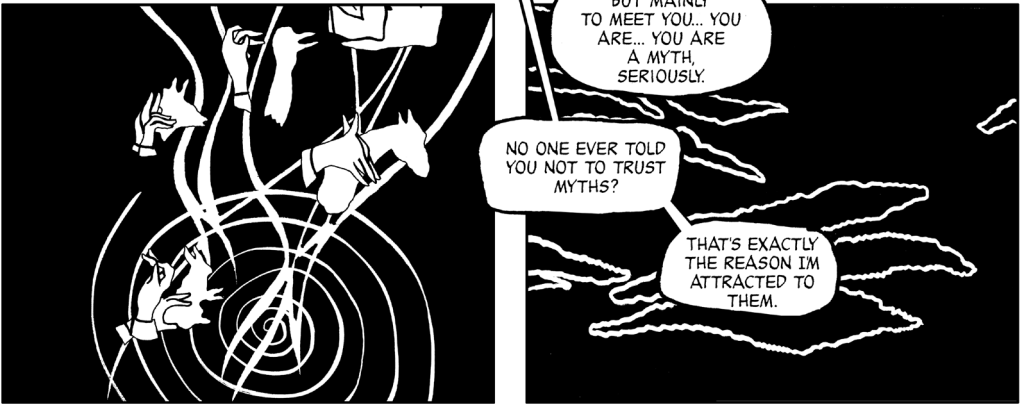

BOTH THINGS, BUT MAINLY TO MEET YOU... YOU ARE... YOU ARE A MYTH, SERIOUSLY.

NO ONE EVER TOLD YOU NOT TO TRUST MYTHS?

THAT'S EXACTLY THE REASON I'M ATTRACTED TO THEM.

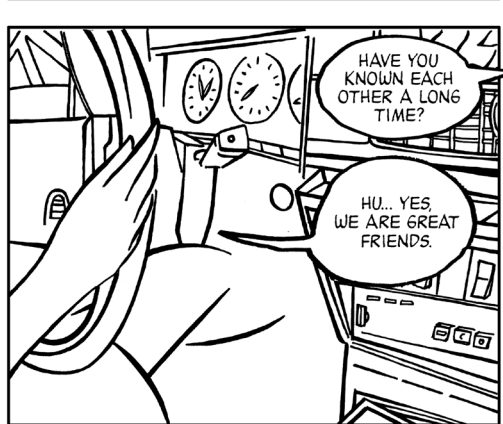
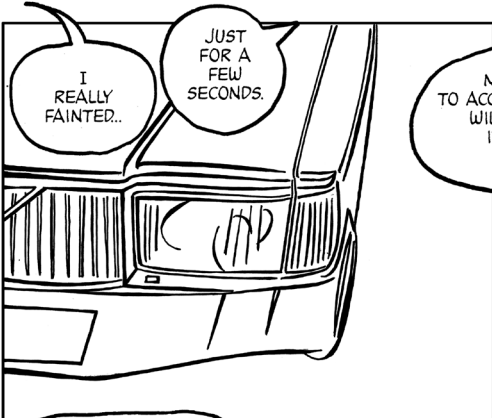
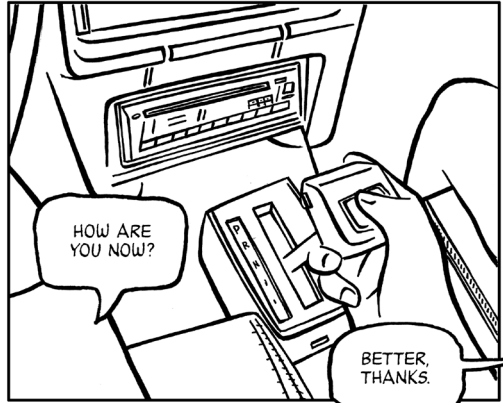
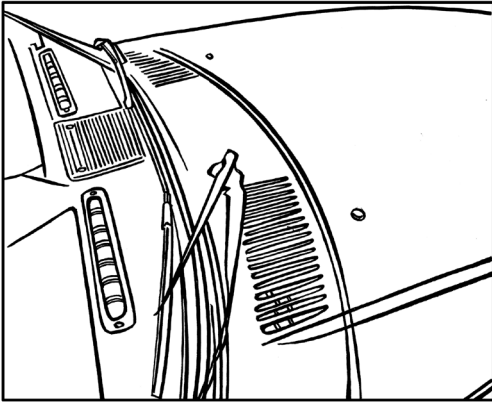



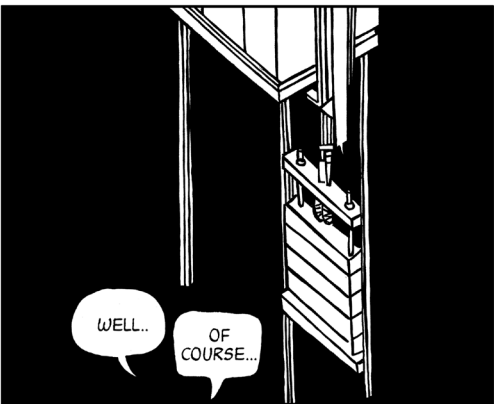
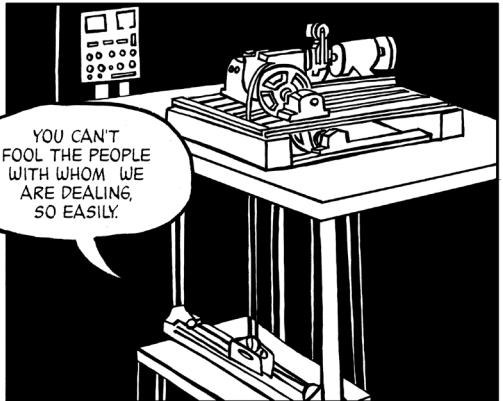
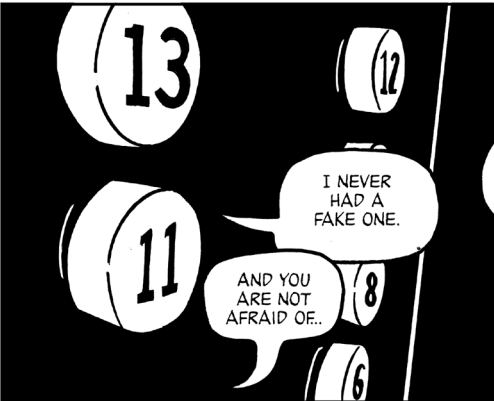
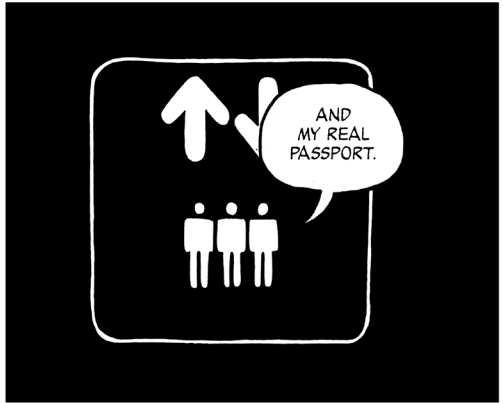

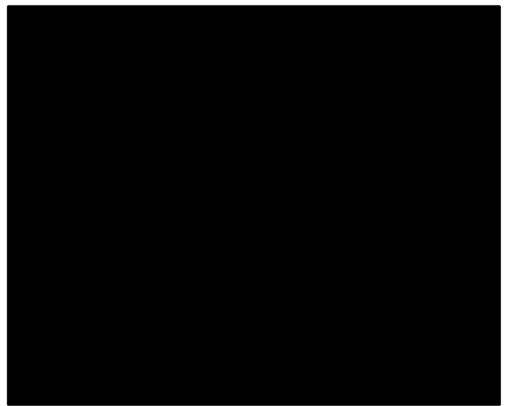



I HAD  
A WEIRD  
DREAM...

WHEN?

IN THE  
DREAM AS WELL,  
I WAS ON THE  
PLANE TO  
STOCKHOLM,  
AND THE  
STRANGE...

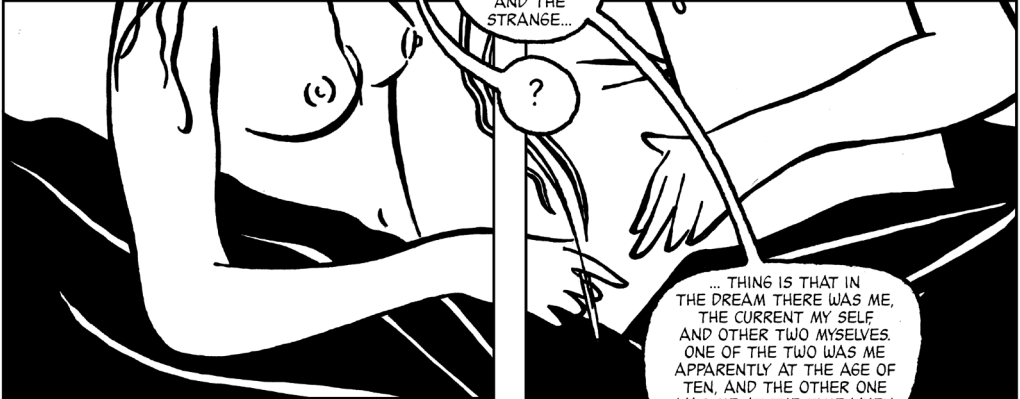

?

... THING IS THAT IN  
THE DREAM THERE WAS ME,  
THE CURRENT MY SELF  
AND OTHER TWO MYSELVES.  
ONE OF THE TWO WAS ME  
APPARENTLY AT THE AGE OF  
TEN, AND THE OTHER ONE  
WAS ME AT THE TIME WHEN  
I GOT MARRIED.



YOU'VE BEEN  
MARRIED?

YES BUT IT  
DIDN'T LEAST  
LONG. SHE LEFT  
ME SHORTLY  
AFTER I WAS  
ARRESTED,  
IN '91

OH YES I  
REMEMBER, YOU  
WERE ARRESTED BUT  
AFTER, EVERYTHING  
WAS SOLVED DURING  
THE TRIAL

YES THE JUDGE SAID  
I WAS A MISFIT WITH AN  
UNHAPPY CHILDHOOD...  
HE'S BEEN... FULL OF MERCY...

AHAHAH!

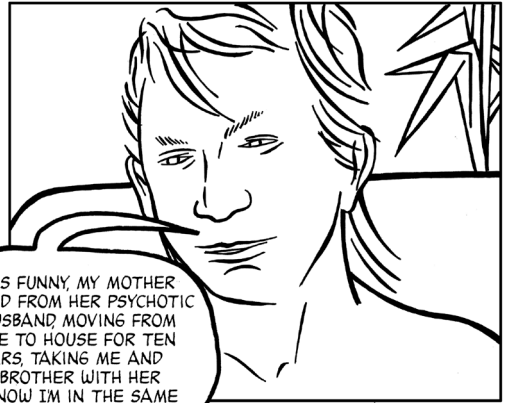

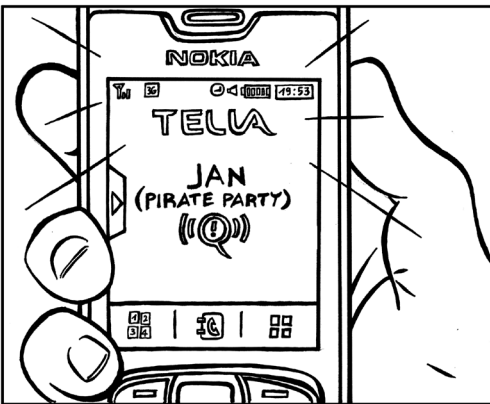
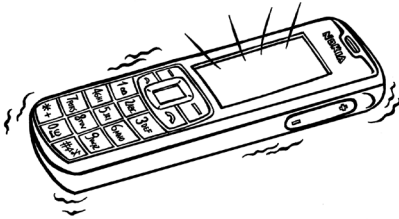
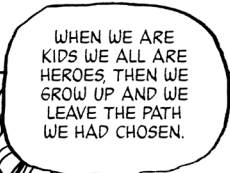

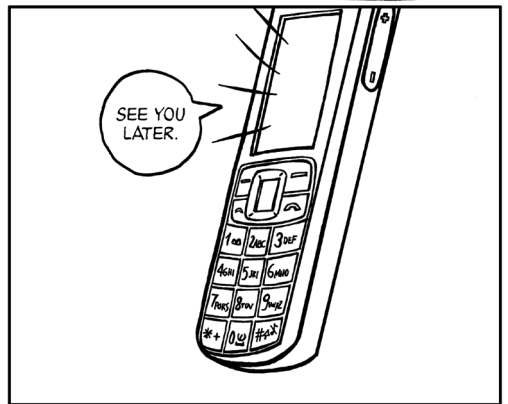
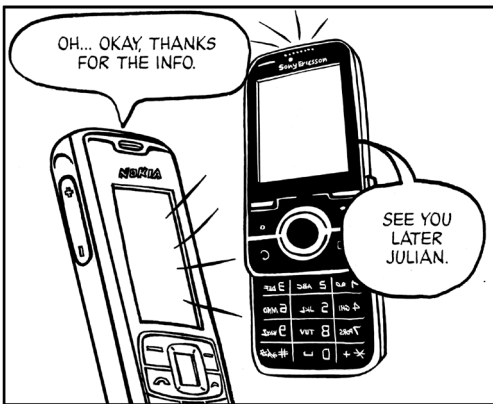
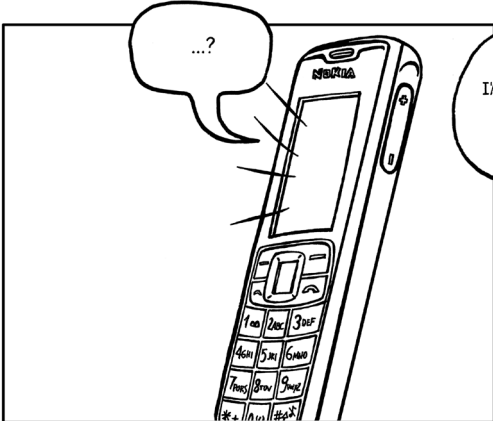

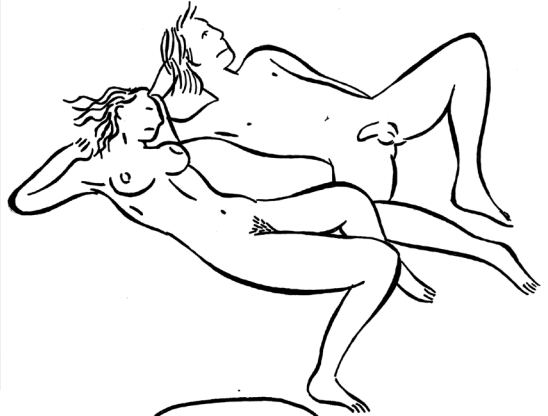
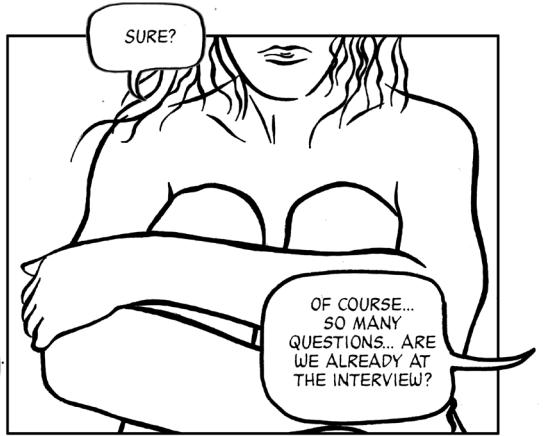

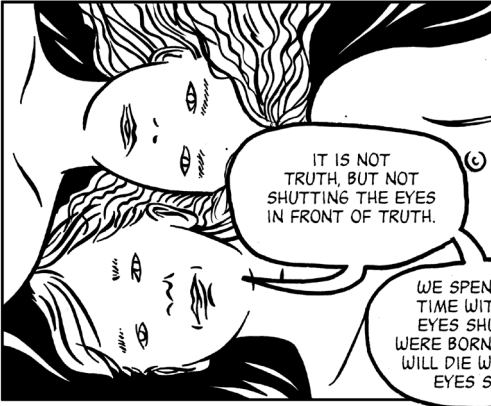

IT IS NOT TRUTH, BUT NOT SHUTTING THE EYES IN FRONT OF TRUTH.

WE SPEND OUR TIME WITH OUR EYES SHUT. WE WERE BORN AND WE WILL DIE WITH OUR EYES SHUT.

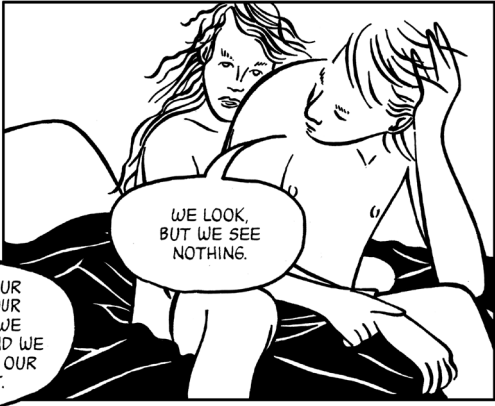

WE LOOK, BUT WE SEE NOTHING.



IF PEOPLE DON'T WANT TO SEE, I CAN DO NOTHING ABOUT IT.

BUT I WILL DO ALL THAT IS IN MY POWER TO PUT TRUTH UNDER EVERYBODY'S EYES.



BUT WHAT IS TRUTH, JULIAN?

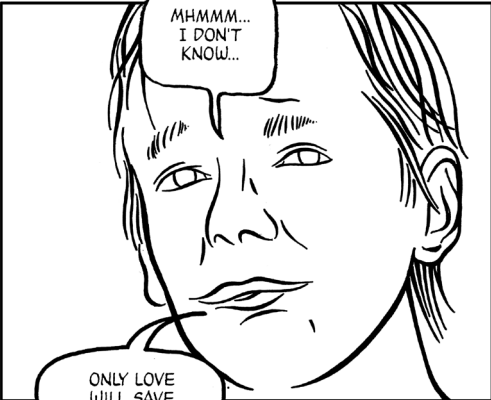

MHMMM... I DON'T KNOW...

ONLY LOVE WILL SAVE THE WORLD?



AHAHAHAHAH

AHHAHAHAHAH

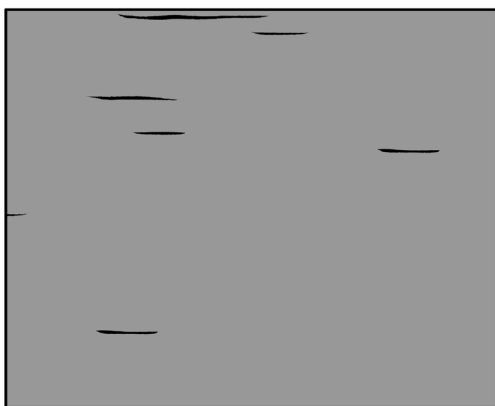
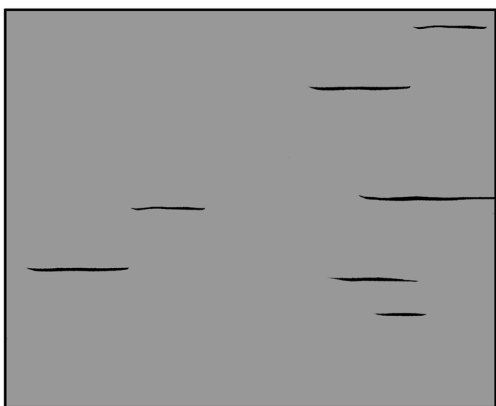
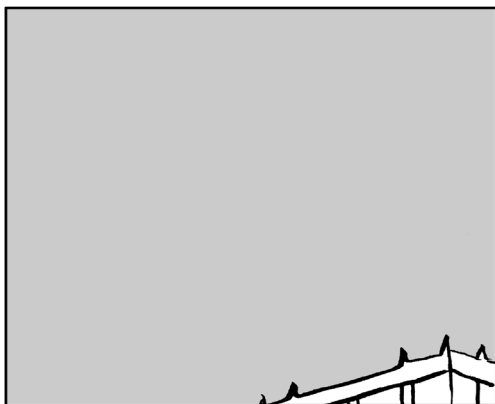
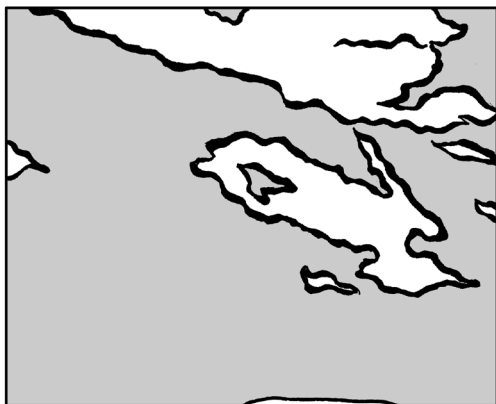



«Then you will know the truth,  
and the truth will set you free».  
**(John 8:32)**

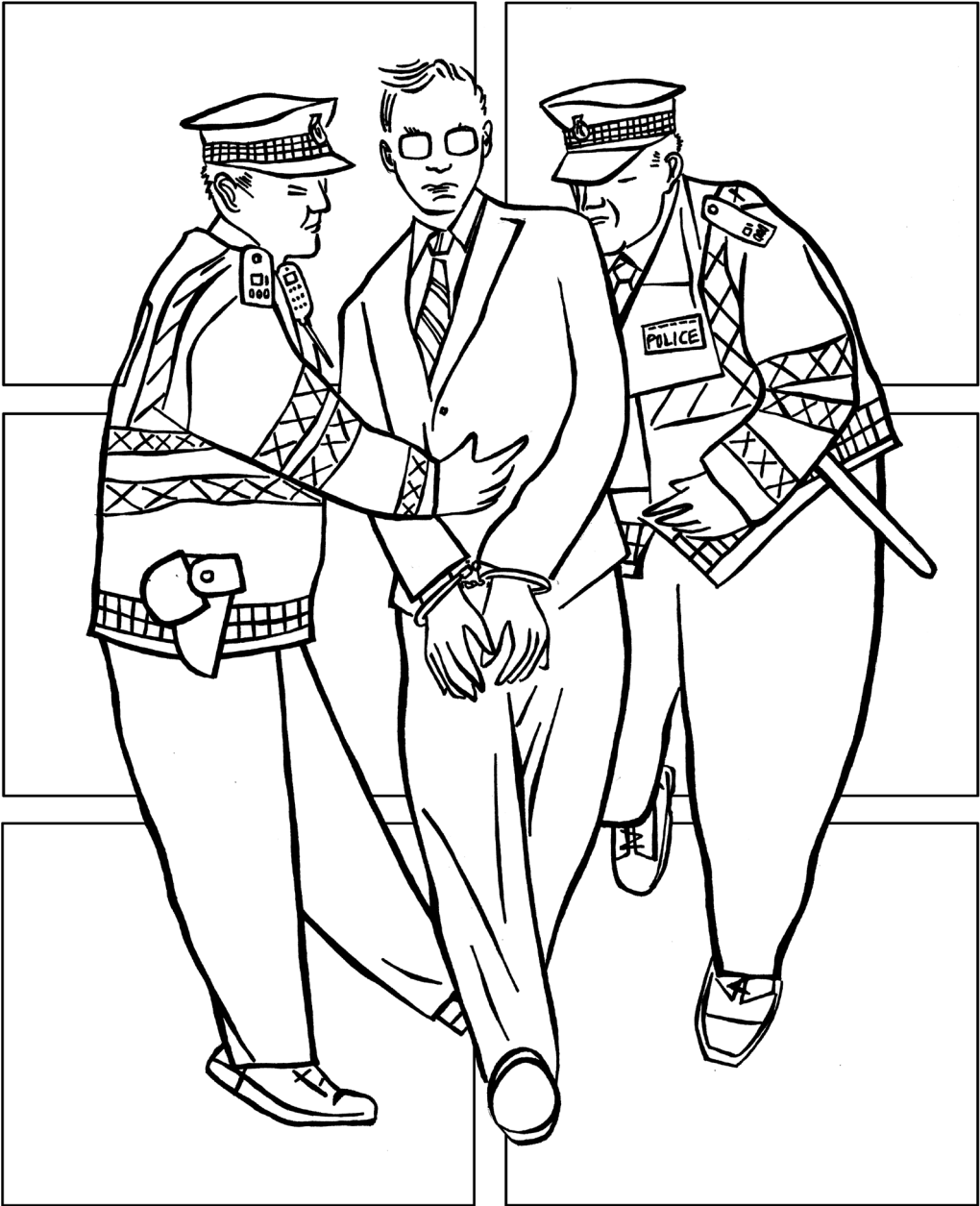

Westminster court jail  
LONDON 2011

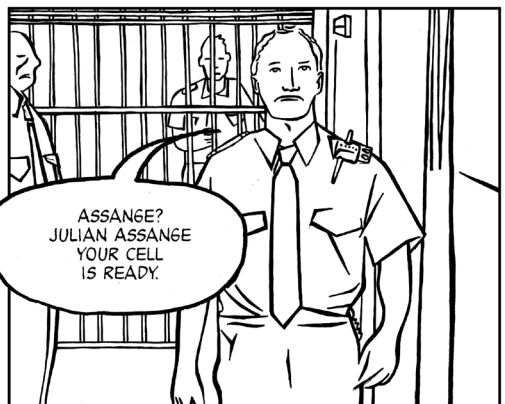

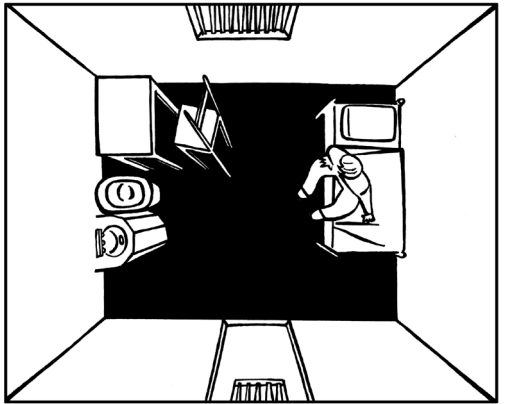
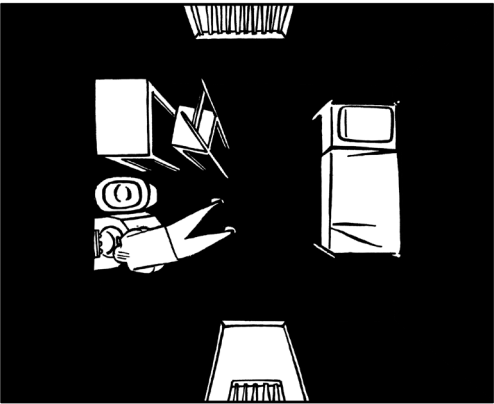
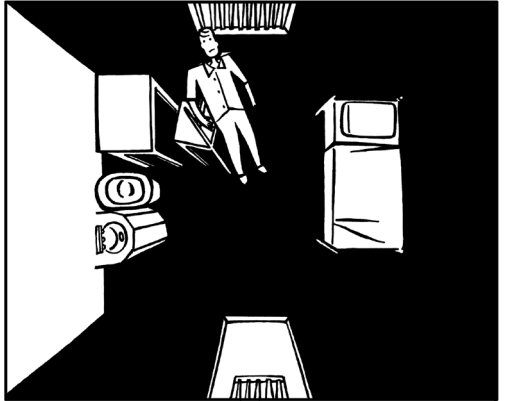
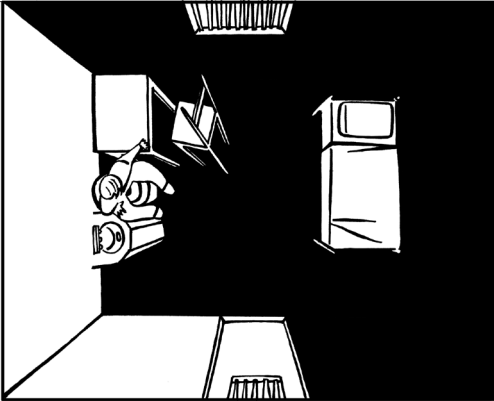
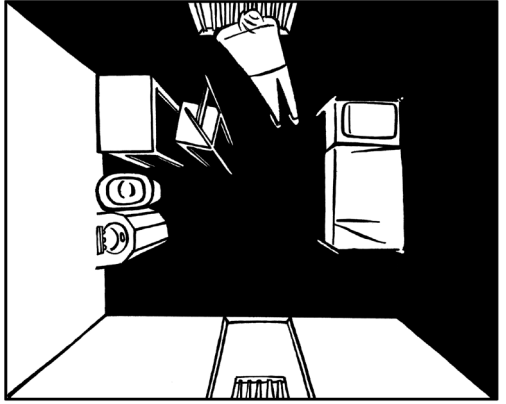
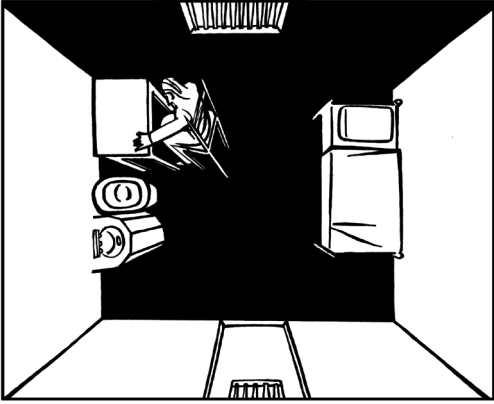

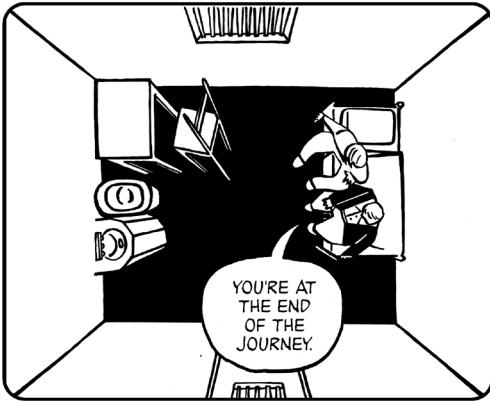

Melbourne University  
2003

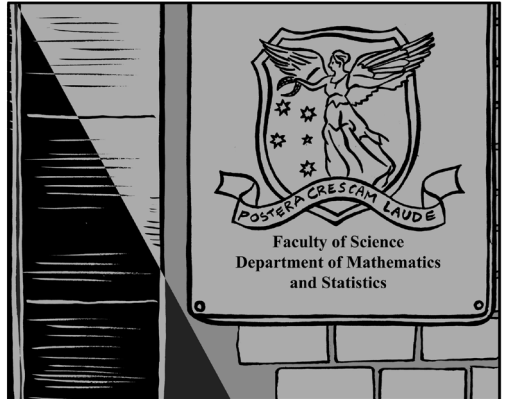

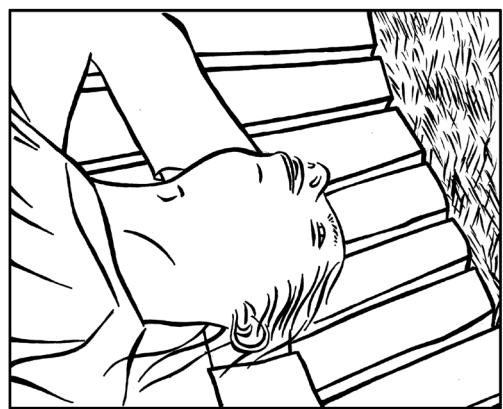
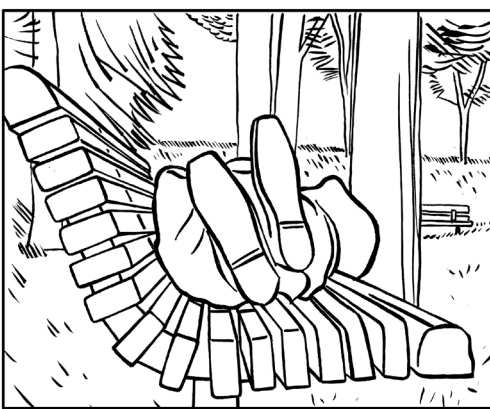
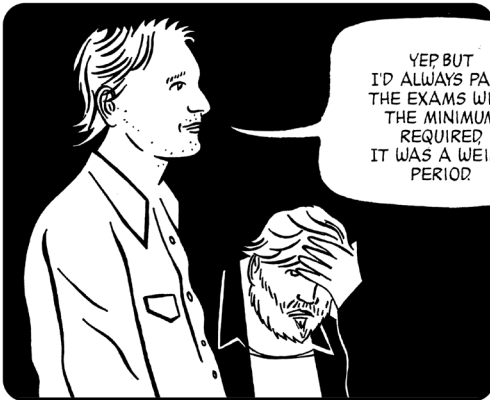
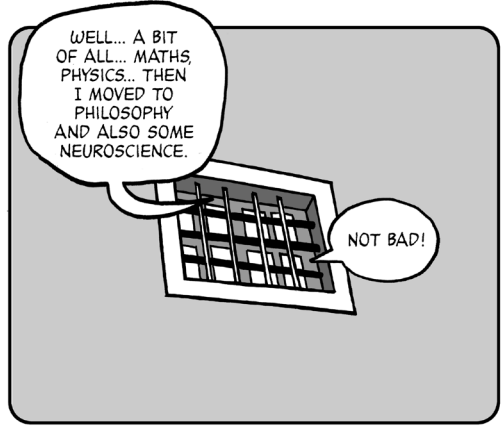

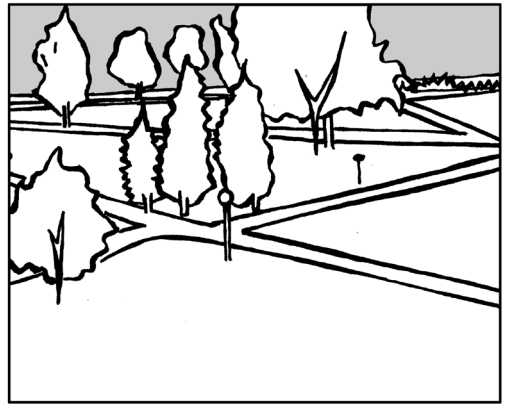
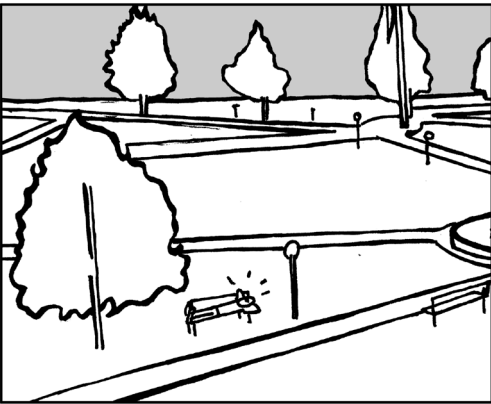
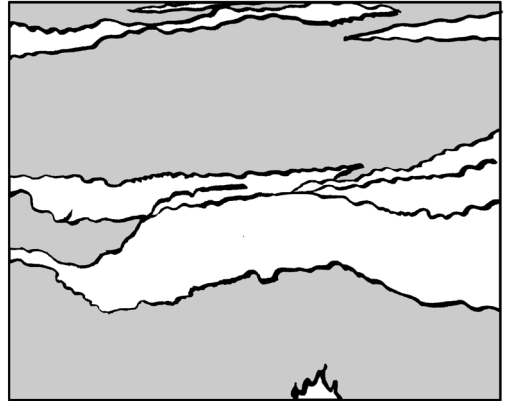
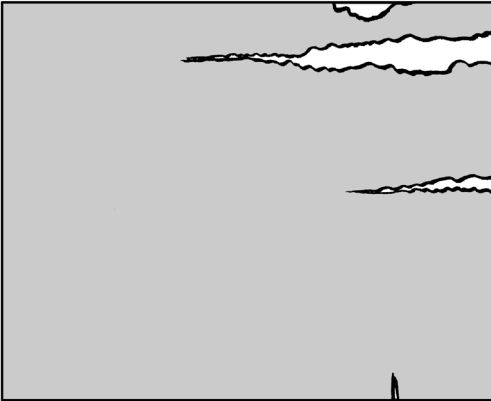
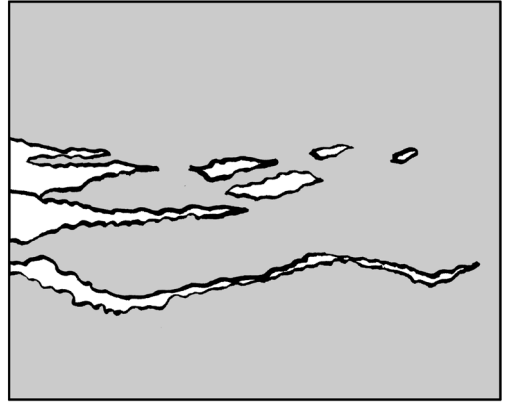
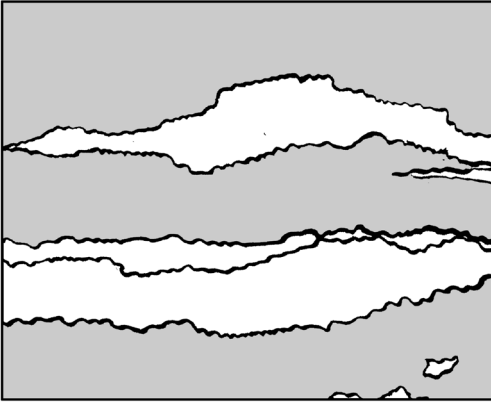



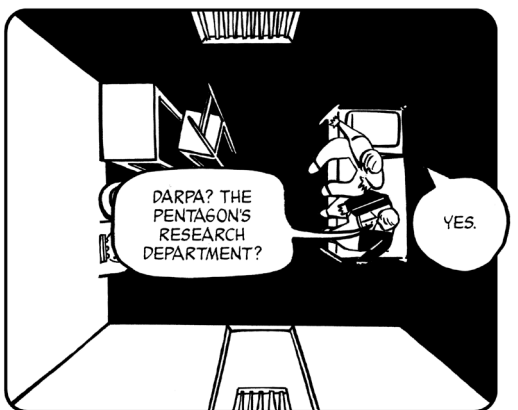
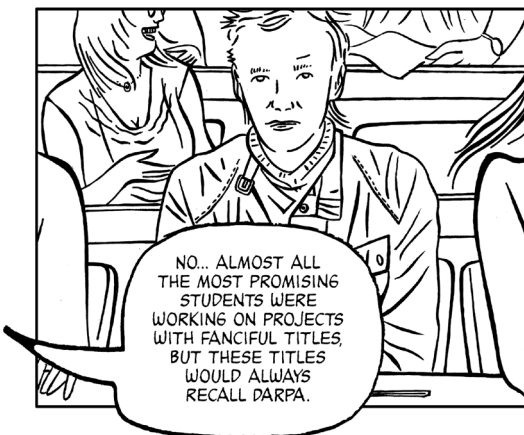
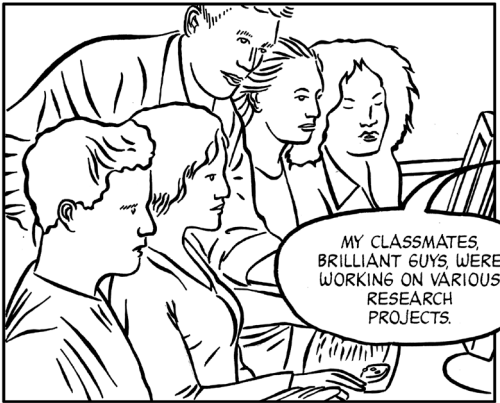

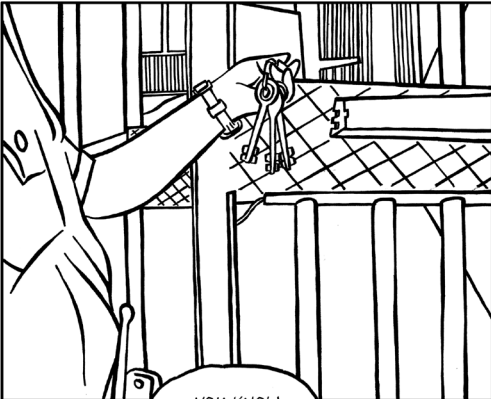
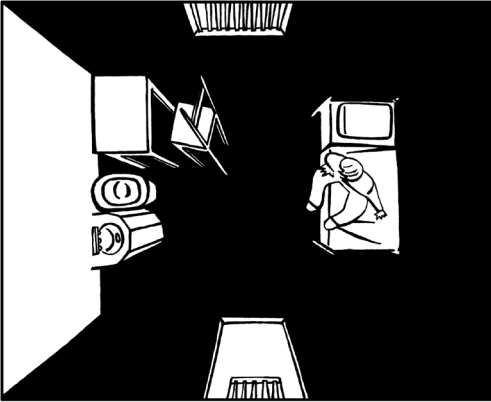



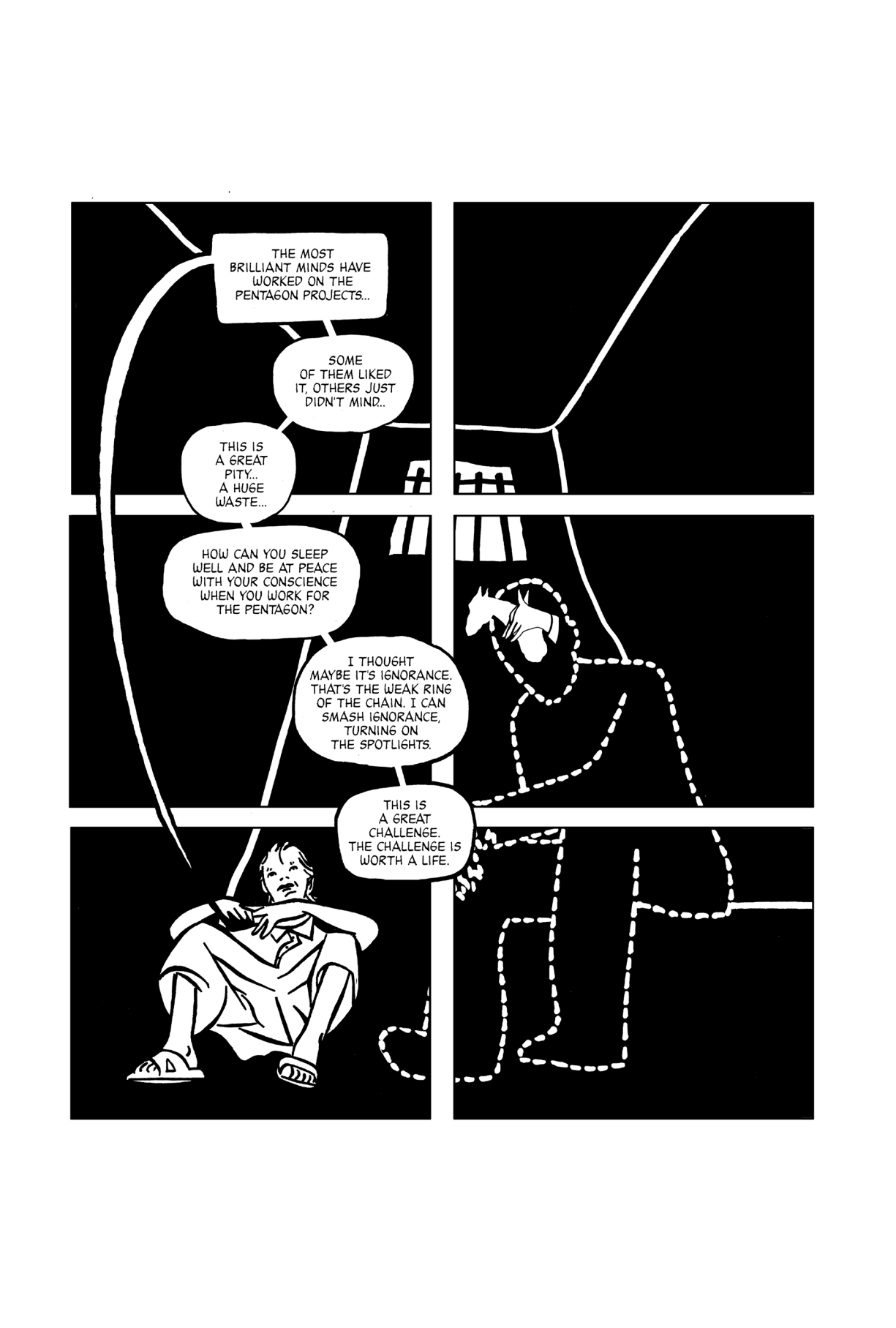

THE MOST  
BRILLIANT MINDS HAVE  
WORKED ON THE  
PENTAGON PROJECTS..

SOME  
OF THEM LIKED  
IT, OTHERS JUST  
DIDN'T MIND..

THIS IS  
A GREAT  
PITY...  
A HUGE  
WASTE...

HOW CAN YOU SLEEP  
WELL AND BE AT PEACE  
WITH YOUR CONSCIENCE  
WHEN YOU WORK FOR  
THE PENTAGON?

I THOUGHT  
MAYBE IT'S IGNORANCE.  
THAT'S THE WEAK RING  
OF THE CHAIN. I CAN  
SMASH IGNORANCE,  
TURNING ON  
THE SPOTLIGHTS.

THIS IS  
A GREAT  
CHALLENGE.  
THE CHALLENGE IS  
WORTH A LIFE.

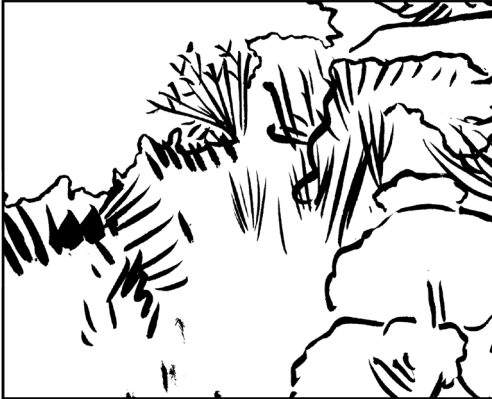

MAGNETIC ISLAND,  
AUSTRALIA  
1983

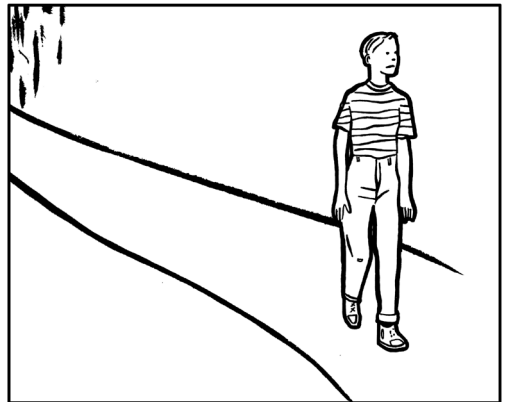

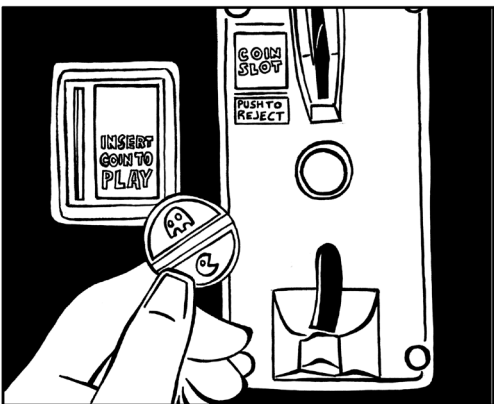

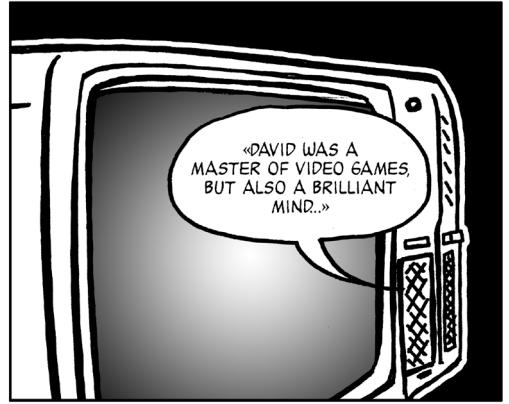
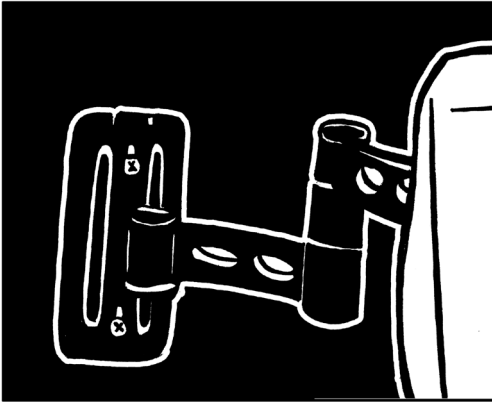

«DAVID WAS A  
MASTER OF VIDEO GAMES,  
BUT ALSO A BRILLIANT  
MIND...»



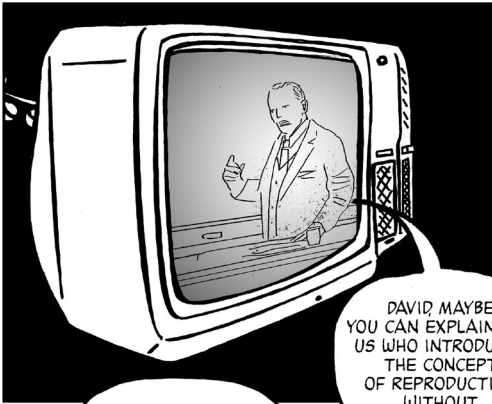

DAVID, MAYBE YOU CAN EXPLAIN TO US WHO INTRODUCED THE CONCEPT OF REPRODUCTION WITHOUT SEX.



HM... YOUR WIFE?



«HE'S A STUDENT THAT GETS GOOD MARKS... WITH A LITTLE ELECTRONIC HELP»

THESE ARE YOUR MARKS?

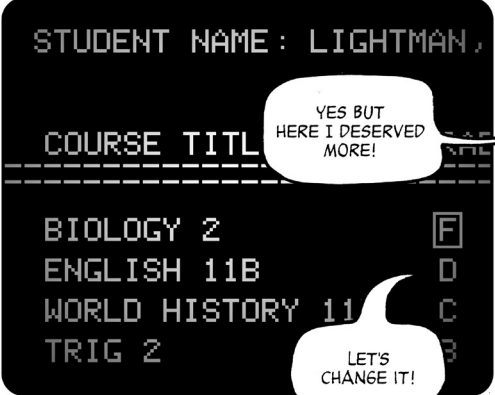

STUDENT NAME: LIGHTMAN,

COURSE TITL

YES BUT HERE I DESERVED MORE!

BIOLOGY 2 [F]  
ENGLISH 11B [D]  
WORLD HISTORY 11 [C]  
TRIG 2 [B]

LET'S CHANGE IT!



DAVID, THEY CAN SEND YOU TO JAIL FOR THAT!



YES BUT ONLY IF YOU ARE EIGHTEEN.



WITHIN A FEW MONTHS, THIS COMPUTER COMPANY, WILL RELEASE HOT STUFF



AND I WANT TO PLAY WITH THOSE VIDEO GAMES.

NUMBERS FOR WITCH CARRIER TUNEL WERE

- \*\*\*> (311) 399-7384
- (311) 399-3802
- (311) 437-8737
- (311) 437-4883
- (311) 437-2997
- (311) 767-7305
- (311) 767-3118
- (311) 938-1913
- (311) 938-8773

Please select a number and then press <RETURN> to beg



SHALL WE PLAY A GAME?

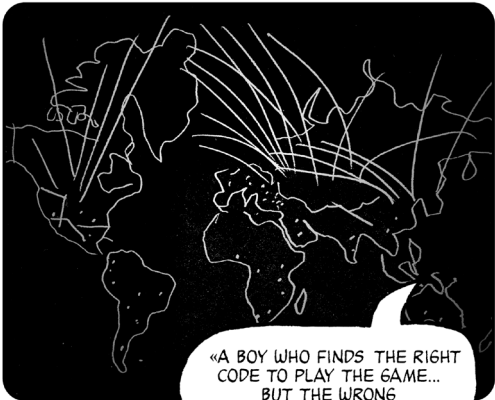

«A BOY WHO FINDS THE RIGHT CODE TO PLAY THE GAME... BUT THE WRONG COMPUTER!»

49 MILLION      NON-FATAL  
72 MILLION      POPULATION

IS THIS A GAME OR IS IT REAL?  
■

---

GAME TIME ELAPSED      EST

45 HRS 34 MIN 00 SEC      27

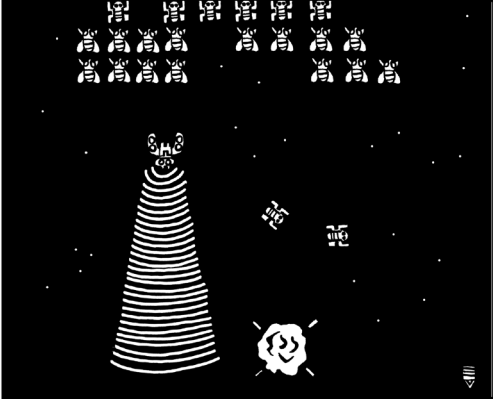

GAME OVER



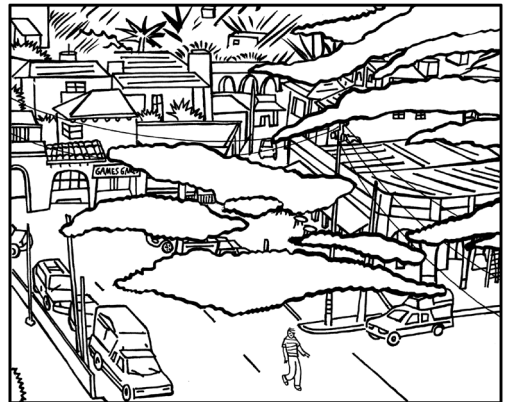
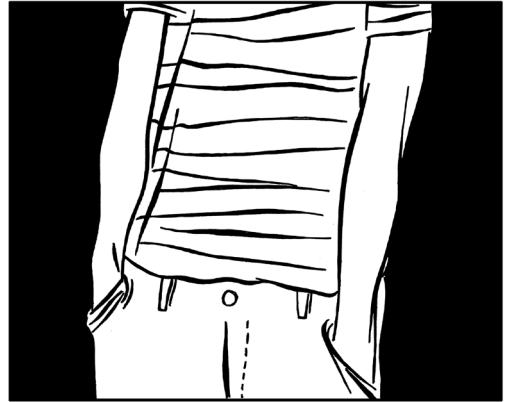

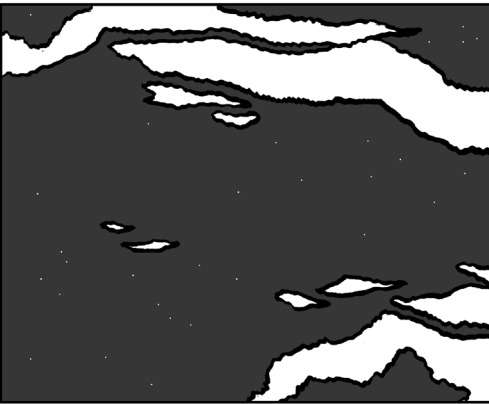
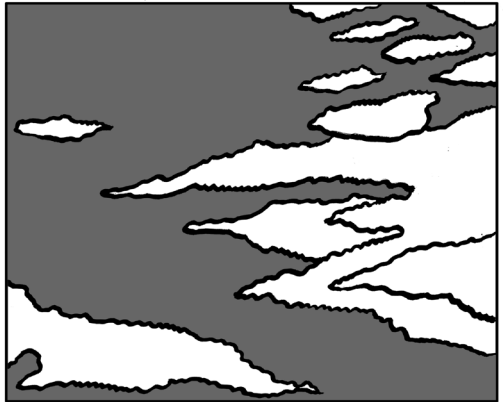
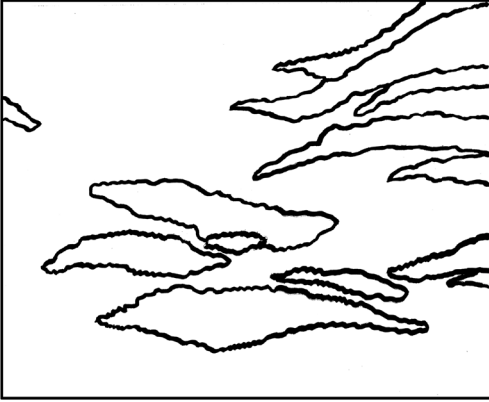



Daniel  
Assange

## UPDATE 2011 TO2021

BY SHEILA NEWMAN

.....

This graphic novel opened with *WikiLeaks*' publication of the "Collateral murder video," in April 2010. Although the video was republished widely by the establishment media, the ire of the United States overtook this exuberant trend, and the same corporate and public media turned on Assange like dogs at their masters' command. Since then, corporate and public journalism have cooperated with the United States' agenda, defaming Assange as a rapist, a degenerate, a spy, and mentally ill.

The original Italian edition of this book left Julian on remand in an English prison in 2011. Leading up to this, Pfc Bradley (later Chelsea) Manning, had made available to WikiLeaks, in 2010, secret military documents on the US war in Afghanistan and Iraq, including the one that came to be known as "Collateral Murder."

In April 2010, *WikiLeaks* had published the material made available by Manning, notably the 'classified' military video (now known notoriously as 'Collateral Murder') where laughing soldiers, in a US Apache helicopter gunship, in New Baghdad, Iraq, shot civilians, whom the military later said had been mistaken for armed combatants. Eighteen people were slaughtered, including two Reuters journalists. Reuters had been denied Freedom of Information about these journalists, whose fate only became known due to *WikiLeaks* publishing this video.

On 20 May 2010, the US military arrested and court martialed Pfc. Manning. She was charged with downloading, to her personal computer, the "Collateral Murder" video, along with other secret State Department documents, and leaking them to *WikiLeaks*.

In July 2010, *WikiLeaks* had published and made available to *The Guardian*, *The New York Times*, and *Der Spiegel*, "The Afghan War Logs," a huge leak of more than 75,000 secret documents with records of previously unknown civilian casualties caused by the US and coalition forces, information about

Julian Assange  
SATURDAY 2 JANUARY  
2021 at 11:25 am

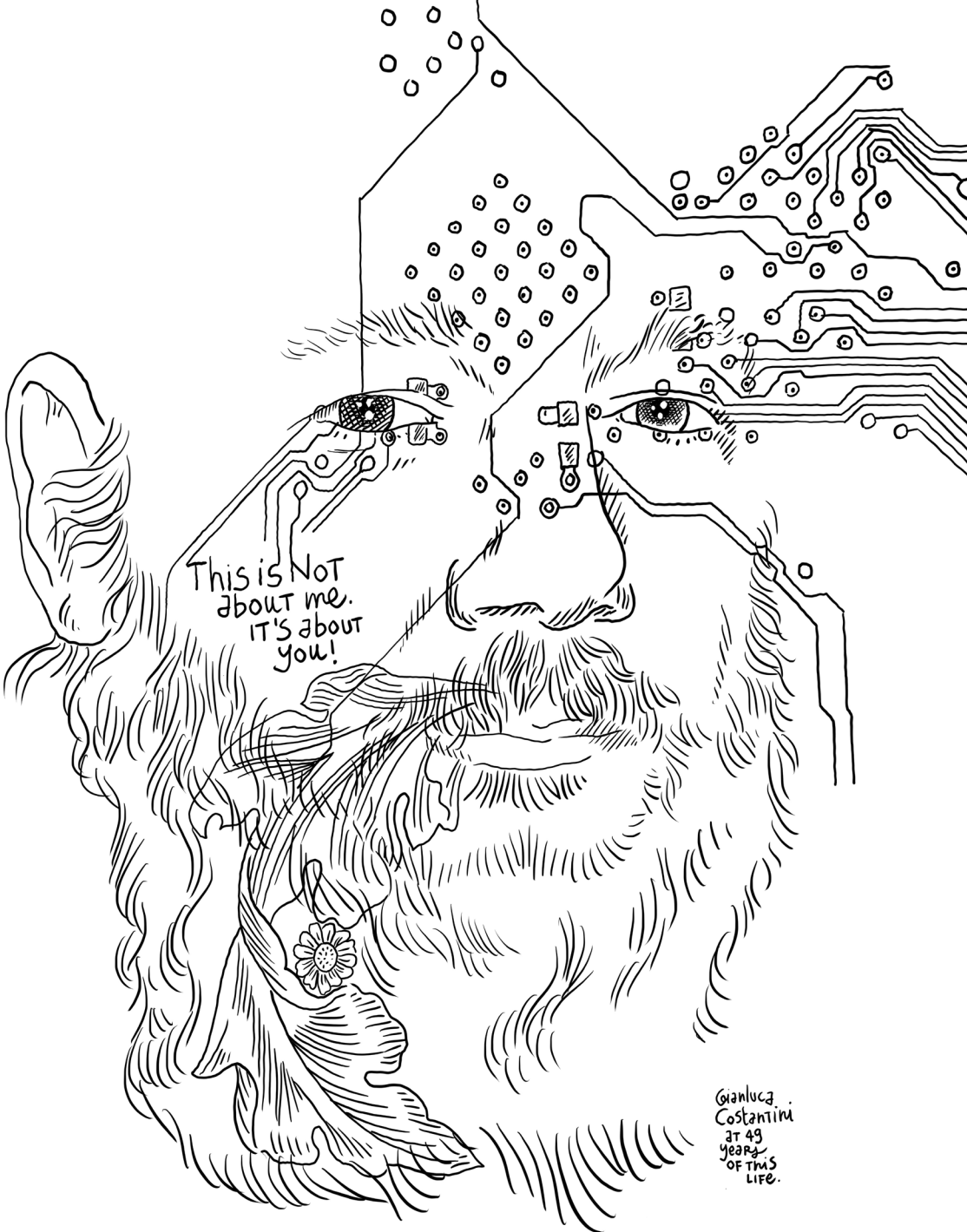

This is Not  
about me.  
IT'S about  
you!

Giulio  
Costantini  
at 43  
years  
of this  
life.

the hunt for Osama bin Laden, and descriptions of increasing Taliban involvement. Around 20,000 of these documents remain unpublished, to minimise harm, at the request of the leak-source, whose identity is still unknown. They have been widely published in the mainstream press and are now part of global public knowledge.

For the United States, the problem emerged of how to stop *WikiLeaks* from publishing more of its criminal secrets. Since Julian was its chief editor and creator, they looked for ways to prosecute him. The US Justice Department considered using the archaic *US Espionage Act* (1917) to prevent *WikiLeaks* from posting other secret war crime documents.

Julian was detained in an English prison from 8 December 2010, pending an application for his extradition to Sweden to answer questions about an alleged rape which purportedly took place in August 2010. This was despite the fact that he had already answered questions voluntarily, in person, in Sweden, after which the police closed the case for lack of evidence, and gave Assange permission to leave Sweden.

While Assange was in England, a special prosecutor in Sweden reopened the case, with lesser, but related, charges. Assange's lawyers had well-grounded suspicions that the Swedes had reopened the case at the behest of the United States, with whom Sweden has an extradition treaty and a history of political deference. Later these suspicions would prove to be completely right.

Assange denied guilt, saying he would answer questions, if the Swedish Government would guarantee not to allow him to be extradited to the United States. When he could not obtain that guarantee, he said he would consent to be interviewed, but only whilst remaining in Britain. Next, on 20 November 2010, the Swedish police issued an international arrest warrant. Assange gave himself up to the British police, and was remanded in custody after an extradition hearing. There was a second extradition hearing on 16 December 2010, and Assange was released from prison on £240,000 bail. After hearings going all the way to the Supreme Court on 30 May 2011, the English court ruled that Assange should be extradited to Sweden, on the basis that European law permitted such a demand.

On 19 June 2012, in fear of his life,<sup>1</sup> Assange broke bail and successfully sought political asylum in the Ecuadorian Embassy in London. He remained there until 11 April 2019.

On 21 August 2013, the US Army Court sentenced Chelsea Manning to 35 years prison.

Unbeknownst to the world public, or Assange's lawyers, Swedish prosecutor Marianne Ny, contacted the English Crown Prosecution Service in 2013 to let it know that she was going to withdraw the charges and international warrant for Julian's arrest, because they were plainly excessive relative to the alleged crime.<sup>2</sup> In an action demonstrating political influence on the British justice system, biased against Assange, in favour of the United States, the British Prosecution Service tried to convince Ny not to drop the case for extradition. These communications were only revealed in 2018, although it was obvious to many that something like this must be going on.

It seems that the Crown Prosecution Service succeeded in getting Prosecutor Ny to keep up the persecutory processes against Assange, despite public disapproval from within the Swedish legal fraternity.

---

1        Assange had exposed the concealment of terrible crimes by the most powerful in America, and public figures responded with calls for his assassination. President Obama's Vice President, Joe Biden, described Assange as a 'high-tech terrorist' in 2010. When asked, Hillary Clinton said that she did not remember having called for him to be droned, but that, if she had, it would have been a 'joke'. See also leaked documents discussed on The Young Turks in the episode entitled, "Hillary On Droning Julian Assange: I Was Just Joking! Probably..." Oct 25, 2016. <https://www.youtube.com/watch?v=ErH29hrpqvg>. Given the US record on political assassinations, Assange had reason to fear for his life. See, for instance, Susan Wright, "Did Hillary Clinton Suggest a Drone Strike to Stop WikiLeaks Founder, Julian Assange? Red State, 3 October 2016, <https://redstate.com/sweetie15/2016/10/03/hillary-clinton-suggest-drone-strike-stop-wikileaks-founder-julian-assange-n62304>, and Ed Pilkington, "Suleimani killing the latest in a long, grim line of US assassination efforts," The Guardian, <https://www.theguardian.com/us-news/2020/jan/04/us-political-assassinations-history-iran-suleimani>, and NBC News article: "Assange lawyer condemns calls for assassination of WikiLeaks' founder," 2 December 2010, <https://www.nbcnews.com/id>

2        See for instance, Bowcott, Owen; MacAskill, Ewen, <https://www.theguardian.com/media/2018/feb/11/sweden-tried-to-drop-assange-extradition-in-2013-cps-emails-show>, The Guardian, 11 February 2018.

Finally, however, in March 2015, Sweden allowed Assange to respond to questions from the embassy. Most of the charges had expired under the Swedish statute of limitations by then.

On 17 January 2017, the Obama administration commuted Chelsea Manning's sentence and she was released from prison on 17 May 2017, after serving seven years.

On 19 February 2019, *La Fuente* newspaper reported that Ecuadorian President Lenin Moreno and his family had availed themselves of offshore companies (notably INA Investment Corp) to buy costly items, and to receive odd, possibly suspicious, payments.<sup>3</sup> Following this, on 1 March 2019, supporting documents were published at inapapers.org. These documents apparently show that Moreno and his friends resorted to “at least a dozen offshore companies incorporated in various tax havens” for the purpose of carrying out “a series of crimes including money laundering, tax fraud, influence peddling, and the collection of bribes (bribery) to the detriment of the Ecuadorian state.”

Meanwhile, in the US, on 16 March 2019, showing enormous courage and principle, Manning refused to testify about *WikiLeaks* to a grand jury and was jailed again.

On 2 April 2019, Ecuadorian President Lenin Moreno claimed *WikiLeaks* had listened in on his private phone and hacked photos of his domestic life. There was no evidence of any involvement by *WikiLeaks* or Assange, but it seems that Moreno was trying to deflect from the corruption allegations reported in *La Fuente* on 19 February 2019. The accusations against *WikiLeaks* were concocted as an official excuse to evict Assange from the embassy. The Ecuadorian National Assembly passed a resolution “inviting the Foreign Ministry to take action against Assange’s asylum on the basis of the INApapers leak ‘in the national interest’ if it considers it pertinent to do so”.<sup>4</sup>

---

3 Christian Zurita Ron and Fernando Villavicencio, “El Laberinto offshore del círculo presidencial,” [The Offshore Labyrinth of the Presidential Circle], 19 February 2019. <https://periodismodeinvestigacion.com/2019/02/19/el-laberinto-offshore-del-circulo-presidencial/>

4 WikiLeaks, 3 April 2019, <https://defend.wikileaks.org/2019/04/03/ecuador-twists-embarassing-inapapers-into-pretext-to-oust-assange/>

On 17 May 2019, Swedish Prosecutor Ny officially suspended Sweden's investigations and revoked the warrant to arrest Assange. Sweden kept open the option of resuming the process if Assange came to Sweden before August 2020.

On 11 April 2019, the day of Assange's arrest in London, the US opened a sealed document dated 6 March 2018, charging him with 'conspiracy to commit computer intrusion' (i.e. hacking into a government computer), based on their interpretation of Assange's involvement with former US Army intelligence analyst, Chelsea Manning.

Also on 11 April 2019, Assange was arrested and dragged out of the embassy by English police, on charges of having jumped bail. This was, of course, a reference to his flight for his life to the Ecuadorian Embassy, when menaced with extradition to Sweden, whence he knew it was intended to extradite him to the United States.

Ecuadorian President Rafael Correa had been openly sympathetic to Assange. He had refused to allow police into the embassy, according to his diplomatic rights under the Vienna Convention. Ecuadorian law, however, meant Correa could not serve a third presidential term. The new president, Lenin Moreno, who had been Correa's Vice President, quickly demonstrated hostility towards Assange, and the former president, whom he has pursued internationally for allegations of bribery, whilst overturning Correa's socialist reforms in favour of a close and subservient relationship with the United States and its neoliberal economic agenda.<sup>5</sup>

A few days after Assange was forced out of the Ecuadorian Embassy, and taken prisoner, Moreno put Ecuador in debt to the US controlled

---

5 "Since coming to power last May, President Lenin Moreno – a handpicked successor of Correa – has fought to remove any trace of Correa's influence from the ruling party the charismatic leftist once led." Elliott Gabriel, "Interpol Rejects Demand to Arrest Ecuador's Correa in Politicized "Kidnapping" Case," 21 September 2018, <https://www.mintpressnews.com/interpol-arrest-ecuador-rafael-correa/249698/>

"In office from 2007 to 2017, Ecuador's left-wing president Rafael Correa more than doubled investment in health care. But Lenin Moreno's austerity regime has abandoned that legacy – and is now using the courts to silence those who criticize its response to COVID-19." Denis Rogatyuk, "Ecuador's Government Is Persecuting the Man Who Doubled Health Care Spending," <https://jacobinmag.com/2020/04/ecuador-lenin-moreno-coronavirus-rafael-correa-health-care/>



Giulio  
Contantini

International Monetary Fund (IMF) to the tune of 4.2-billion dollars, which meant that the IMF could dictate to the government to make changes to Ecuadorian social institutions, including instituting austerity measures.

Undercover Global, a Spanish defence and security firm, hired to protect the Ecuadorian Embassy from 2012, also conducted multiple invasive surveillance activities on behalf of the United States CIA,<sup>6</sup> involving filming and recording all Assange's activities inside the embassy, including conversations with his legal team, even when Assange tried to talk to them privately in the toilet area. The capacity for auditory recordings was added under Moreno. Later, British courts would unaccountably allow the United States to use this illegally gathered information, which should have been inadmissible, in their case for extraditing Assange.

This conduct by the British court alone should utterly discredit their mission in the eyes of the world public but, sadly, the mass media has failed to alert and educate the public adequately.

In May 2019, Swedish Deputy Director of Public Prosecutions, Eva-Marie Persson, tried to revive the case to extradite Assange to Sweden. She applied to have him detained ready for the issue of a European arrest warrant. This time, however, she was denied permission to extradite Assange by the Uppsala District Court, which stated that Assange's presence in Sweden was not necessary for the investigation. Persson then talked about issuing a European Investigation Order to interview Assange instead. Finally, the prosecution announced that they had dropped the investigation in November 2019.<sup>7</sup> One effect of continuously revisiting the Swedish 'rape' case was to permit the mass media to renew the rape slurs on Assange again and again, and distract public opinion from the outrageous conduct of the British legal system.

6 José María Irijo, "Spanish security company spied on Julian Assange in London for the United States. Spain's High Court is investigating the director of UC Global S.L. and the activities of his company, which had been hired to protect the Ecuadorian embassy in the English capital." El Pais News, Madrid, 27 September 2019. [https://english.elpais.com/elpais/2019/09/25/inenglish/1569384196\\_652151.html](https://english.elpais.com/elpais/2019/09/25/inenglish/1569384196_652151.html).

7 Wikipedia, "Assange v Swedish Prosecution Authority," [https://en.m.wikipedia.org/wiki/Assange\\_v\\_Swedish\\_Prosecution\\_Authority](https://en.m.wikipedia.org/wiki/Assange_v_Swedish_Prosecution_Authority) citing, "Swedish prosecutor drops Julian Assange rape investigation," The Local (Sweden), 19 November 2019, <https://www.thelocal.se/20191119/swedish-prosecutor-holds-press-conference-in-julian-assange-case/>

To this day, many people in the world think that Assange was guilty of rape. This is because of the eagerness of the corporate media to report and support the Swedish, UK, and United States narrative, in preference to reporting the facts to a public that needs to be properly educated in this matter.

In February 2020, Chelsea Manning's lawyers lodged a motion calling for her to be set free, on the basis that her detention would continue to fail its purpose because she would never agree to testify against *WikiLeaks*.

After another 301 days of imprisonment, Manning was let out of prison, subsequent to a major suicide attempt.

On 1 May 2019, Judge Deborah Taylor condemned Assange to serve 50 weeks in Belmarsh maximum security prison, as punishment for having jumped bail in 2012, flagrantly ignoring Assange's rational fears of unjust political persecution and harm,<sup>8</sup> recognised by the UN in granting him status as a refugee.

On 24 February 2020, a London court, presided by Judge Vanessa Baraitser, began hearing the United States' case to extradite Assange to the US.

On 1 May 2021, Judge Vanessa Baraitser, presiding at the Magistrate's court, disallowed Julian Assange's extradition on medical grounds. She found there was a high risk of his suiciding if confined in a US prison. Outrageously, she threw out the ground of public interest (protection of journalists), and refused to admit the case involved political persecution, or oppression. She seemed to have upheld the honouring of the UK treaty obligations to the United States, of extradition, as the only public interest matter. As mentioned earlier, Baraitser also allowed, as evidence, material illegally collected by UC Global from the Ecuadorian embassy on behalf of the US, despite valid objections from Assange's legal defence.

---

8 "Geneva (5 February 2016) – WikiLeaks founder Julian Assange has been arbitrarily detained by Sweden and the United Kingdom since his arrest in London on 7 December 2010, as a result of the legal action against him by both Governments, the United Nations Working Group on Arbitrary Detention said today. In a public statement, the expert panel called on the Swedish and British authorities to end Mr. Assange's deprivation of liberty, respect his physical integrity and freedom of movement, and afford him the right to compensation" Source: <http://www.ohchr.org/EN/NewsEvents/Pages/DisplayNews.aspx?NewsID=17012&LangID=E>

To some people, her decision on medical grounds, that Assange would probably suicide in US prison conditions, is equivalent to preventing the extradition of a prisoner to Nazi Germany, on grounds that they would probably not survive the concentration camps. The US prison system actually allows major corporations to benefit from slave labour of prisoners; it conducts secret trials; and it holds prisoners indefinitely without trial – as in Guantanamo Bay Prison. The war crimes and international surveillance of governments and private individuals that Julian Assange exposed, show the United States as a totally rogue state. It is not even a party to the International Criminal Court.

On 13 February, US President Joe Biden's administration formally appealed Judge Barraitser's ruling, declaring it would continue its attempts to have Assange stand trial in the US.

Despite his extraordinarily long bail-skipping sentence having been served, Assange remains in prison as a flight-risk.

Julian Assange has not lived as a free man since June 2012, when he sought refuge in the London Ecuadorian embassy. He has been in prison since his removal from the Ecuadorian embassy in March 2019. If extradited to the United States and tried, the trial will be held in a court in the eastern district of Virginia, where there is strong reliance on military employment, and where the jurors will largely be made up of employees of United States Intelligence agencies, or their spouses. It is unlikely that such a jury would give due consideration to Julian's defense team's arguments, and would quickly find him guilty. Assange risks a potential 175 years imprisonment if this comes to pass.

Pontius Pilate was the judge who condemned Jesus Christ to death, according to the bible. The crime Jesus was punished for was that of leading a religion critical of the values of the Roman State.

Modern authorities try to defend their right to have criminal secrets in order to justify persecuting Julian Assange, who has led a world-wide movement for transparent and just government. If UK judges deliver Assange to authorities who then deliver him to the United States, they may claim that



John  
Pilger

they are only doing their duty under the law, just like Judge Pontius Pilate. I am not religious, but I think this is a valuable parable for our time.

We live in a world, sadly, where wealth disparity and electronic technology has reached a point at which people with financial and political power can do almost anything, and control the way it is reported. They can launch wars for profit, carry out torture, influence the courts and the media, and then they can secretly try and imprison anyone who attempts to expose what they have done. That's why they are persecuting Julian Assange. They are out to prove that they can silence any protest.

These rich power-elites are networked and they back each other up. Julian Assange, as part of the alternative media, exposed this network – and he did not take sides. Even the cowardly mainstream media, that pretends he is not a journalist or a publisher, republished the information he provided. If Julian is extradited to the United States, judged guilty in a rigged court, publishing in the western world will suffer the same fate as publishing in fundamentalist countries. Remember Charlie Hebdo and “We are all Charlie.”

We are all Julian Assange now. Jesus of Nazareth was a local phenomenon that went viral. Julian is a global phenomenon in a global world – but he may be our last because, after him, what individual will ever achieve such a political profile, if the power-elite get their wish for utter media control and total secrecy?

## **Assange and the Australian Government**

Although this book was mostly written by its authors in Italy in 2011, an Australian wrote this final chapter in April 2021. Perhaps the reader wonders what the Australian government has been doing for Assange? The answer is that they have thrown him to the wolves. They excuse their negligence towards a citizen by saying that Assange has recently denied them permission to liaise with him in Belmarsh prison, but this was probably because he knew they were useless. The fact is that the Australian government has persistently ignored the great work that Julian Assange has done through WikiLeaks, preferring to give the nod to the United States

painting of Assange as a criminal. Australia, like Sweden and Britain, has sacrificed political independence and the ability to defend principles and citizens, to a military alliance with the United States. That means that Australia helps the US to cover up war crimes by persecuting those who try to expose them.

Recently a series of horrendous Australian war crimes involving sadistic murders of 39 civilians and prisoners by (or at the instruction of) members of the Australian special forces, which were subsequently covered up by ADF personnel, were exposed by an Australian army lawyer, David McBride.<sup>9</sup> Even though this was confirmed in Brereton investigation, and documented on Australian public television's *Four Corners*, and the head of the Australian army has publicly apologised to Afghanistan and the world, the Australian Government intends to go ahead and prosecute the whistleblowing Australian lawyer for revealing these very war crimes.

## **Australia and Assange**

And what of the Australian mass media? It has fallen into line with the United States mass media, with which it is largely syndicated. It has repeated the same slurs, so that now Australians who don't read outside the mass media, mostly believe that Assange is a rapist who stole harmless secrets from the United States military and endangered some unspecified lives.

Are there protests in Australia about Assange? On Friday evenings a few people gather outside Flinders Street Station in Melbourne, with placards, and make speeches in defense of Assange. A small group also gathers every Friday afternoon outside Sydney Town Hall. There are more or less active groups in the other main cities of Australia and some regional groups. People write letters to their political representatives, which usually go unanswered. There is the occasional question in parliament. And there is a group of

---

<sup>9</sup> David William McBride is an Australian whistleblower and former British Army major and Australian Army lawyer who from 2014 to 2016 made information (the "Afghan Files") on war crimes committed by Australian soldiers in Afghanistan available to the Australian Broadcasting Corporation, who broadcast details in 2017. In 2018, he was charged with several related offences, and was awaiting trial at time of writing in April 2021. The allegations were reviewed and, for at least 39 deaths, were found to be true in the *Brereton Report*, which resulted from the Inspector-General of the Australian Defence Force Afghanistan Inquiry.

parliamentarians who are known as 'Friends of Julian Assange', but they can't do much, and what they do goes largely unreported by the corporate press, and thus unheeded by the masses. The Labor Party in opposition has made muted statements about Assange having served long enough, but it also depends on the corporate media and the approval of the United States. In Julian's home town, Melbourne, Melbourne4wiki coordinates a number of supportive activities, including the Home Run for Julian regional tour and a planned international tour, both involving Assange's father, John Shipton. His mother has made many efforts to get him set free.

During Julian's most recent trial by Judge Barraitser, there were some Australian government observers. To the amazement of other observers, they reported back that Julian was receiving a fair trial, giving the Australian government another excuse to do nothing.

How has the Australian government dealt with the fact that Assange is now the most famous refugee in the world? It has not dealt with it at all. It has looked the other way.

Capable,  
Generous men  
DO NOT CREATE  
VICTIMS,  
They NURTURE  
VICTIMS.

Giulian  
Cattina



## HISTORICAL BACKGROUND OF THE INFORMATION ERA

---

**1837**

Samuel Morse inventes the telegraph.

**1876**

Alexander Graham Bell invents the phone.

**1957**

The Advanced Research Projects Agency (ARPA, and later DARPA) passes under the control of US Ministry of Defense.

**1961**

The MIT buys PDP1 (computer with screen and keyboard). A group of students, passionate about model railway, use it secretly to control exchanges. It is the first case of hacking.

**1962**

The same Students create Space War, first video game the ever.

**1969**

Four computers are connected to each other creating ARPANET. In the following months, the network expands linking research centers and universities.

**1970**

The NCP protocol is developed, making it possible to create applications for the network.

**1971**

The Yippie publishes the first phone hacking magazine, YIPL / TAP.

**1971**

Project Gutenberg begins

**1972**

In order to coordinate the programming work of ARPANET, a system of digital communication at a distance is developed, which is read using Basic language. It is called electronic mail or e-mail.

**1972**

Robert Kahn and Vint Cerf develop the TCP / IP protocol.

**1972**

Pong, the first video game for bar use, is born.

**1973**

Texas Instruments launches DataMath, the first pocket calculator in history.

**1975**

Altair 8800, the first personal computer (PC) ever, is sold as a kit.

**1976**

The first Apple computer (Apple I) is released on the market. The architects are two young boys, Steve Jobs and Steve Wozniak who were both hackers.

**1977**

Two students from Chicago invent the modem.

**1977**

Commodore launches PET 2001 one of the first successes of consumer electronics.

**1978**

Ward Christensen and Randy Seuss create the first bulletin board system, BBS.

**1979**

USENET, is born.

**1980**

The TCP / IP protocol is classified as priority protocol in the U.S. defense system.

**1980**

Market release of the Sinclair ZX-80, the first PC under \$ 200.

**1981**

Commodore VIC 20 gets on the market.

**1982**

The writer William Gibson coins the term “cyberspace”.

**1982**

The movie, Tron, is released.

**1982**

Birth of EUnet (European UNIX Network). The first connections are made between the Netherlands, Denmark, Sweden and the UK.

**1982**

The Commodore 64 is released in the U.S.

**1984**

Birth of the DNS system.

**1983**

Release of the movie Wargames.

**1984**

UK gives life to JANET a network to connect University centers.

**1984**

The U.S. Congress approves the Comprehensive Crime Control Act, which gives to USSS (U.S. intelligence) jurisdiction over credit cards and computer fraud.

**1984**

Richard Stallman creates the Free Software Foundation.

**1985**

Internet (name given to the network) becomes a priority for world scientific research, mainly due to e-mail, BBS and forums.

**1985**

The domains assignment begins. The first is symbolics.com.

**1985**

Launch of the first BBS police trap. Later other ones will be created.

**1988**

IANA - the Internet Assigned Numbers Authority - settlement is registered.

**1988**

IRC (Internet Relay Chat) is born.

**1989**

The World Wide Web project (Www) is presented by Tim Berners-Lee at CERN of Geneva.

**1990**

World.std.com is the first commercial provider in internet history.

**1990**

Mitch Kapor and Barlow found the Electronic Frontier Foundation.

**1991**

Linus Torvalds creates the new operating system LINUX.

**1992**

Jean Armour Polly coined the expression "to surf on the Internet".

**1993**

The browser Mosaic is launched.

**1993**

Online websites in the world number 623.

**1994**

Netscape markets its first browser. It is also the first application directly downloadable from the Internet.

**1994**

Amazon.com is launched

**1995**

Ebay is launched

**1996**

Online websites worldwide number over 100,000.

**1996**

Larry Page and Sergey Brin launch Google

**1997**

the online websites worldwide are over one million users are estimated around 100 million.

**1997**

The NASA website dedicated to the Pathfinder robot mission on Mars - that transmitted "live" images from the red planet - records, in the first 4 days, more than 100 million accesses. NASA is forced to create twenty-five mirror sites to be able to manage the data traffic.

**1998**

Google launched

**1998**

Online websites worldwide number 3.7 million.

**1999**

The number of websites reaches 10 million.

**2001**

Wikipedia is launched

**2004**

Mark Zuckerberg, Eduardo Saverin, Andrew McCollum,

Dustin Moskovitz and Chris Hughes launch Facebook.

**2005**

Chad Hurley, Jawed Karim and Steve Chen launch YouTube

**2006**

Biz Stone, Evan Williams, Noah Glass and Jack Dorsey launch Twitter

## **Wikileaks Timeline**

**2006**

Computer programmer and activist, Julian Assange, launches Wikileaks.

Here are dates for WikiLeaks' major revelations and related events.

**2007**

**November:** WikiLeaks publishes a standard operating procedures manual for US soldiers supervising al-Qaida suspects sequestered in Camp Delta, Guantanamo Bay, Cuba.

**2008**

**September:** Two months prior to the US presidential election, WikiLeaks publishes leaked emails from Republican vice-presidential candidate, Sarah Palin's Yahoo account.

## 2009

**November:** WikiLeaks publishes over half-a-million pager messages, which it says were sent on Sept. 11, 2001.

## 2010

**April:** WikiLeaks publishes a 'classified' military video (now known as 'Collateral Damage') where laughing soldiers, in a U.S. Apache helicopter gunship, in New Baghdad, Iraq, shoot civilians whom the military later says were thought to be armed combatants. 18 people were slaughtered, including two Reuters journalists.

**May-June:** U.S. military arrest and court-martial Pfc. Bradley (aka Chelsea). She is charged with downloading, to her personal computer, the collateral damage video, along with other secret State Department documents, and leaking them to Wikileaks.

**July:** WikiLeaks publishes and makes available to The Guardian, The New York Times, and Der Spiegel, "The Afghan War Logs," a huge leak of more than 75,000 secret documents with records of previously unknown civilian casualties caused by the US and coalition forces, information

about the hunt for Osama bin Laden, and descriptions of increasing Taliban involvement. Around 20,000 of these documents remain unpublished, to minimise harm, at the request of the leak-source.

**August:** WikiLeaks founder Julian Assange answers Stockholm police questions about rape allegations, which he denies, and they close the case due to lack of evidence.

**October:** WikiLeaks publishes the 'Iraq War Logs', consisting of almost 400,000 secret military documents implicating Iraqi security forces in the torture of prisoners of war, documenting more civilian deaths, and claiming Iranian support for Iraqi insurgents.

**November:** Sweden issues international arrest and extradition warrant for Assange.

WikiLeaks publishes the initial 250,000 of over 3 million leaked US diplomatic cables from almost 300 American consulates and embassies, covering the years from 1966 to 2010.

**December:** Assange is detained in London from 8 December 2010 pending an

application for his extradition to Sweden to answer questions about alleged rape. After a second extradition hearing, he is released on \$240,000 bail.

## 2011

**February:** Against the backdrop of the Egyptian ‘Spring’, Wikileaks publishes seven cables from the Cairo US Embassy, on Egypt’s human rights and civil liberties.

**April:** Wikileaks publishes “The Guantanamo Files,” around 800 secret military documents containing the official allegations of terrorism against prisoners at Guantanamo Bay, Cuba.

**May:** UK Supreme court rules against Assange in favour of extradition to Sweden.

**October:** Wikileaks temporarily stops publishing leaked documents in order to concentrate on fund-raising, after they are taken off Amazon’s servers and probably cut off by major credit card companies, Western Union, and PayPal.

## 2012

**February:** Wikileaks begins publishing around 5 million

emails leaked from ‘global intelligence’ company, Stratfor.

**June:** Assange takes refuge in Ecuador’s London embassy, from which he seeks political asylum.

**July:** Wikileaks starts publishing over two million leaked emails from 680 Syrian government officials and firms, going back to 2006.

**August:** Political asylum is granted to Assange, who is still in Ecuador’s London embassy. Bradley Manning is condemned to 35 years prison in a military trial. She officially identifies as female called Chelsea.

## 2013

Wikileaks continues to publish leaked documents, including those from major trade deals like the Trans-Pacific Partnership and the Transatlantic Trade and Investment Partnership.

**October:** Unbeknownst to the world public, the Swedish prosecutor Marianne Ny contacts the English Crown Prosecution Service (CPS) on 18 October 2013 to let it know that she is going to withdraw the charges and international warrant for



Julian Assange  
SPEECH AT  
ECUADORIAN  
EMBASSY  
08-19-2012

Assange's arrest, because they are plainly excessive, relative to the alleged crime. In an action demonstrating politicisation of the UK justice system, biased against Assange, in favour of the United States, the British Prosecution Service convinces Sweden not to drop the case for extradition. These communications will only be revealed in 2018, although it is obvious to many that something like this must be going on.

## 2014

**June:** Accompanied by its own analysis, WikiLeaks publishes a secret draft of the Financial Services Annex of the Trade in Services Agreement (TISA).

**July:** WikiLeaks publishes a secret gagging order, from the Supreme Court of Victoria, Australia, forbidding the Australian press from reporting on a multimillion-dollar bribery investigation involving the nation's central bank and several international leaders.

## 2015

**June:** WikiLeaks publishes documents leaked from the Saudi foreign ministry.

**July:** WikiLeaks begins publishing leaked US National

Security Agency documents, revealing spying on international politicians, including German Chancellor, Angela Merkel, French President François Hollande, U.N. Secretary-General Ban Ki-moon, Israeli Prime Minister, Benjamin Netanyahu, and Italian Prime Minister, Silvio Berlusconi.

## 2016

**July:** WikiLeaks publishes almost 20,000 emails and 8,000 attachments from leaders of the US Democratic National Committee during the US election campaign. Many show hostility to Bernie Sanders, Hillary Clinton's then competitor for Democrat Presidential Nominee. Although the US attempts to portray these leaks as incidents of Russian hacking, Assange denies this.

**October:** WikiLeaks publishes over 2,000 emails hacked from the account of John Podesta, then campaign chairman for Democratic presidential nominee Hillary Clinton.

## 2017

**January:** President Obama commutes Chelsea Manning's sentence, near the end of his presidency.

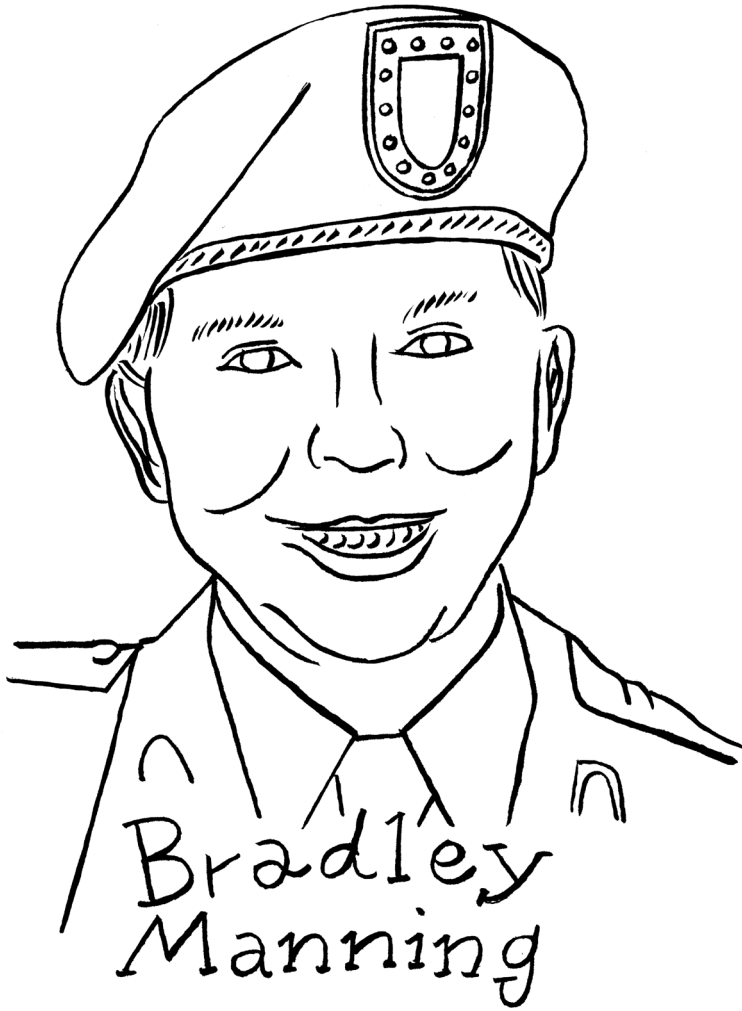

**March:** Wikileaks begins publishing ‘Vault 7,’ thousands of CIA documents related to CIA hacking, malware, and spyware, deployed on smart TVs, smartphones, and internet browsers.

**May:** Chelsea Manning is freed from prison.

**September:** Wikileaks begins publishing 650,000 important documents said to be from Russian surveillance contractors.

**October:** Mike Pompeo, CIA Director, says the US is working to ‘take down’ Wikileaks, designated, “an enormous threat.”

**December:** Assange gets Ecuadorian citizenship.

## 2018

**April:** The US Democratic Party national committee (DNC) files a civil legal suit against Wikileaks for posting its hacked emails.

**May:** A US Army Court of appeals validates Chelsea Manning’s conviction.

**November:** A US lawyer’s document accidentally reveals that Assange has been secretly charged by the United States.

**February:** The Guardian reports that newly released emails reveal that the English Crown Prosecution Service influenced Swedish authorities to maintain charges and the international arrest warrant against Assange, when Sweden was eager to drop the case. This demonstrated the political nature of the UK’s treatment of Assange and that he had been correct in saying that the UK was exploiting the rape charges as a ploy to have him extradited to Sweden and thence to the U.S.

## 2019

**March:** Manning refuses to testify about Wikileaks to a grand jury and is jailed again.

**April:** Ecuadorian President Lenín Moreno claims Wikileaks listened in on his private phone and hacked photos of his domestic life. No evidence is provided. Wikileaks describes these charges as untrue.

British police enter Ecuador’s London embassy and extract Assange by force, on charges of jumping bail.

Opening a sealed document dated 6 March 2018, the US charges Assange with

‘conspiracy to commit computer intrusion’.

**May:** A US grand jury adds 17 espionage charges as an interpretation of Assange’s involvement with former US Army intelligence analyst Chelsea Manning. The total of 18 charges could mean a sentence of up to 175 years imprisonment.

Swedish prosecutors reopen their investigation, stating they will pursue Assange’s extradition to Sweden.

**June** - The US Justice Department formally requests Assange’s extradition from Britain on charges of conspiring to hack US government computers and breaking espionage law.

**November:** Sweden abandons the rape charges because the evidence is insufficient for a conviction and due to legal limitation periods.

## 2020

**February:** A London court starts the extradition hearings.

**October:** Judge Vanessa Baraitser announces that her ruling on extradition will be on Jan. 4, 2021.

## 2021

**January:** UK judge Vanessa Baraitser rules on January 4 against Julian Assange being extradited to the US on medical grounds that the US prison system lacks the ability to prevent Assange’s consequent likely suicide. Baraitser however throws out the grounds of public interest (protection of journalists); political persecution, and oppression. She holds the UK treaty obligations to the United States to be the only public interest matter. Baraitser also allows, as evidence, material illegally collected by UC Global from the Ecuadorian embassy on behalf of the US, despite objections from Assange’s legal defense.

US President Joe Biden’s administration formally appeals the ruling, declaring it will continue its attempts to have Assange stand trial in the US. Despite his bail-skipping sentence having been served, Assange remains in prison as a flight-risk.

Julian Assange has not lived as a free man since June 2010, when he sought refuge in the London Ecuadorian Embassy. He has been in prison since

his removal from the Embassy in March 2019. If extradited to the United States and tried, the trial will be held secretly in a military court, in a state where witnesses will tend to be reliant on military employment. He risks a potential 175 years imprisonment.

